

# INSTRUCTION MANUAL

---

## DIGITAL STORAGE OSCILLOSCOPE DCS-4605



■ **About a trademark, a registered trademark**

A company name and the brand name mentioned in this instruction manual are the trademark or the registered trademark of each company or group in each country and region.

■ **About this instruction manual**

When copying the part or all of contents of this instruction manual, seek the copyright holder.

In addition, the specifications of the product and the contents of this instruction manual are subject to change without notice for improvement. Please check to our website for the latest version.

# Table of Contents

USING THE PRODUCT SAFELY.....	I - V
<b>1. GETTING STARTED .....</b>	<b>1</b>
1-1. Main Features .....	1
1-2. Panel Overview .....	3
1-2-1. Front Panel.....	3
1-2-2. Rear Panel .....	6
1-2-3. Display.....	7
1-3. Setting up the Oscilloscope .....	8
<b>2. QUICK REFERENCE .....</b>	<b>11</b>
2-1. Menu Tree and Shortcuts .....	11
2-1-1. Acquire key.....	11
2-1-2. CH1/CH2 key .....	12
2-1-3. Cursor key 1/2.....	12
2-1-4. Cursor key 2/2.....	13
2-1-5. Display key .....	13
2-1-6. Autoset key.....	14
2-1-7. Hardcopy key .....	14
2-1-8. Help key .....	14
2-1-9. Horizontal menu key .....	14
2-1-10. Math key 1/2 (+/-).....	15
2-1-11. Math key 2/2 (FFT).....	15
2-1-12. Measure key.....	16
2-1-13. Run/Stop key.....	16
2-1-14. Save/Recall key 1/9 .....	17
2-1-15. Save/Recall key 2/9 .....	17
2-1-16. Save/Recall key 3/9 .....	18
2-1-17. Save/Recall key 4/9 .....	18
2-1-18. Save/Recall key 5/9 .....	18
2-1-19. Save/Recall key 6/9 .....	19
2-1-20. Save/Recall key 7/9 .....	19
2-1-21. Save/Recall key 8/9 .....	20
2-1-22. Save/Recall key 9/9 .....	20
2-1-23. Trigger key 1/5 .....	21
2-1-24. Trigger key 2/5 .....	21
2-1-25. Trigger key 3/5 .....	22
2-1-26. Trigger key 4/5 .....	22
2-1-27. Trigger key 5/5 .....	23
2-1-28. Utility key 1/10 (Utility #1).....	23

2-1-29. Utility key 2/10 (Utility #2)	24
2-1-30. Utility key 3/10 (Utility #3)	24
2-1-31. Utility key 4/10 (Hardcopy -Save All)	24
2-1-32. Utility key 5/10 (Hardcopy -Save Image)	25
2-1-33. Utility key 6/10 (Probe compensation)	25
2-1-34. Utility key 7/10 (Go-NoGo)	25
2-1-35. Utility key 8/10 (Data Logging 1/2)	26
2-1-36. Utility key 9/10 (Data Logging 2/2)	26
2-1-37. Utility key 10/10 (Self CAL Menu)	26
2-1-38. Default Settings	27
2-2. Built-in Help	28
<b>3. MEASUREMENT</b>	<b>29</b>
3-1. Basic Measurements	29
3-1-1. Activating a channel	29
3-1-2. Using Autoset	30
3-1-3. Running and stopping the trigger	31
3-1-4. Changing the horizontal position and scale	32
3-1-5. Changing the vertical position and scale	33
3-1-6. Using the probe compensation signal	34
3-2. Automatic Measurements	36
3-2-1. Measurement items	36
3-2-2. Automatically measuring the input signals	38
3-3. Cursor Measurements	39
3-3-1. Using the horizontal cursors	39
3-3-2. Using the vertical cursors	40
3-4. Math Operations	41
3-4-1. Overview	41
3-4-2. Adding, subtracting or multiplying signals	42
3-4-3. Using the FFT function	43
3-5. Go No-Go Testing	44
3-5-1. Overview	44
3-5-2. Edit: NoGo When	44
3-5-3. Edit: Source	45
3-5-4. Edit: NoGo Violation Conditions	45
3-5-5. Edit: Template (boundary)	46
3-5-6. Run Go-NoGo Tests	50
3-6. Data Logging	51
3-6-1. Overview	51
3-6-2. Edit: Source	51
3-6-3. Edit: Setup Parameters	52
3-6-4. Run Data logging	53

<b>4.</b>	<b>CONFIGURATION .....</b>	<b>54</b>
4-1.	Acquisition .....	54
4-1-1.	Selecting the acquisition mode .....	54
4-1-2.	Real time vs Equivalent time sampling mode .....	56
4-2.	Display .....	56
4-2-1.	Selecting vector or dot drawing .....	56
4-2-2.	Accumulating the waveform .....	57
4-2-3.	Adjusting the display contrast .....	57
4-2-4.	Selecting the display grid .....	58
4-3.	Horizontal View .....	58
4-3-1.	Moving the waveform position horizontally .....	58
4-3-2.	Selecting the horizontal scale .....	59
4-3-3.	Selecting the waveform update mode .....	59
4-3-4.	Zooming the waveform horizontally .....	60
4-3-5.	Viewing waveforms in the X-Y mode .....	61
4-4.	Vertical View (Channel) .....	62
4-4-1.	Moving the waveform position vertically .....	62
4-4-2.	Selecting the vertical scale .....	62
4-4-3.	Selecting the coupling mode .....	62
4-4-4.	Inverting the waveform vertically .....	63
4-4-5.	Limiting the waveform bandwidth .....	64
4-4-6.	Probe attenuation level and type .....	64
4-5.	Trigger .....	65
4-5-1.	Trigger type .....	65
4-5-2.	Trigger parameter .....	65
4-5-3.	Configuring the edge trigger .....	67
4-5-4.	Configuring the video trigger .....	68
4-5-5.	Configuring the pulse width trigger .....	69
4-5-6.	Manually triggering the signal .....	70
4-6.	Remote Control Interface .....	71
4-7.	Control with the "FreeWave" .....	72
4-7-1.	System requirements .....	72
4-7-2.	Icon .....	72
4-7-3.	Connect screen .....	73
4-7-4.	Image screen .....	74
4-7-5.	Data screen .....	75
4-7-6.	Command screen .....	76
4-8.	System Settings .....	77
4-8-1.	Viewing the system information .....	77
4-8-2.	Selecting the language .....	77

<b>5.</b>	<b>SAVE/RECALL</b> .....	<b>78</b>
5-1.	File Structures .....	78
5-1-1.	Display image file format.....	78
5-1-2.	Waveform file format.....	78
5-1-3.	Setup file format.....	80
5-1-4.	Using the USB file utilities.....	81
5-2.	Quick Save (HardCopy).....	83
5-3.	Save .....	84
5-3-1.	File type/source/destination .....	84
5-3-2.	Saving the panel settings.....	85
5-3-3.	Saving the waveform .....	86
5-3-4.	Saving the display image.....	87
5-3-5.	Saving all.....	87
5-4.	Recall.....	89
5-4-1.	File type/source/destination .....	89
5-4-2.	Recalling the default panel settings.....	89
5-4-3.	Recalling a reference waveform to the display.....	90
5-4-4.	Recalling panel settings.....	91
5-4-5.	Recalling a waveform.....	92
<b>6.</b>	<b>MAINTENANCE</b> .....	<b>93</b>
6-1.	Vertical Resolution Calibration .....	93
6-2.	Probe Compensation.....	94
<b>7.</b>	<b>APPENDIX</b> .....	<b>96</b>
7-1.	Fuse Replacement .....	96
7-2.	DCS-4605 Specifications .....	97
7-2-1.	Common specifications.....	97
7-2-2.	Probe Specifications .....	99
7-3.	Dimensions.....	100
7-4.	FAQ .....	101

---

---

## USING THE PRODUCT SAFELY

---

---



### ■ Preface

To use the product safely, read this instruction manual to the end.  
Before using this product, understand how to correctly use it.

If you read this manual but you do not understand how to use it, please ask us or your local dealer. After you read this manual, save it so that you can read it, anytime as required.

### ■ Pictorial indication

This instruction manual and product show the warning and caution items required to safely use the product. The following pictorial indication and warning character indication are provided.

<Pictorial indication>	
	<p>Some part of this product or the instruction manual may show this pictorial indication. In this case, if the product is incorrectly used in that part, a serious danger may be brought about on the user's body or the product.</p> <p>To use the part with this pictorial indication, be sure to refer to this instruction manual.</p>
 	<p>If you use the product, ignoring this indication, you may get killed or seriously injured. This indication shows that the warning item to avoid the danger is provided.</p> <p>If you incorrectly use the product, ignoring this indication, you may get slightly injured or the product may be damaged. This indication shows that the caution item to avoid the danger is provided.</p>

Please be informed that we are not responsible for any damages to the user or to the third person, arising from malfunctions or other failures due to wrong use of the product or incorrect operation, except such responsibility for damages as required by law.

---

---

## USING THE PRODUCT SAFELY

---

---



- **Do not remove the product's covers and panels**  
Never remove the product's covers and panels for any purpose. Otherwise, the user's electric shock or fire may be incurred.
- **Warning on using the product**  
Warning items given below are to avoid danger to user's body and life and avoid the damage or deterioration of the product.  
Use the product, observing the following warning and caution items.
- **Warning items on power supply**
  - Power supply voltage  
The rated power supply voltages of the product are 100, 120, 220 and 240VAC. The rated power supply voltage for each product should be confirmed by reading the label attached on the back of the product or by the "rated" column shown in this instruction manual.  
The specification of power cord attached to the products is rated to 125VAC for all products which are designed to be used in the areas where commercial power supply voltage is not higher than 125VAC. Accordingly, you must change the power cord if you want to use the product at the power supply voltage higher than 125VAC. If you use the product without changing power cord to 250VAC rated one, electric shock or fire may be caused.  
When you used the product equipped with power supply voltage switching system, please refer to the corresponding chapter in the instruction manuals of each product.
  - Power cord  
**(Important) The attached power cord set can be used for this device only.**  
If the attached power cord is damaged, stop using the product and call us or your local dealer. If the power cord is used without the damage being removed, an electric shock or fire may be caused.
  - Protective fuse  
If an input protective fuse is blown, the product does not operate. For a product with external fuse holder, the fuse may be replaced. As for how to replace the fuse, refer to the corresponding chapter in this instruction manual.  
If no fuse replacement procedures are indicated, the user is not permitted to replace it. In such case, keep the case closed and consult us or your local dealer. If the fuse is incorrectly replaced, a fire may occur.

---

---

## USING THE PRODUCT SAFELY

---

---

### ■ **Warning item on Grounding**

If the product has the GND terminal on the front or rear panel surface, be sure to ground the product to safely use it.

### ■ **Warnings on Installation environment**

- Operating temperature and humidity  
Use the product within the operating temperature indicated in the “rating” temperature column. If the product is used with the vents of the product blocked or in high ambient temperatures, a fire may occur.  
Use the product within the operating humidity indicated in the “rating” humidity column. Watch out for condensation by a sharp humidity change such as transfer to a room with a different humidity. Also, do not operate the product with wet hands. Otherwise, an electric shock or fire may occur.
- Use in gas  
Use in and around a place where an inflammable or explosive gas or steam is generated or stored may result in an explosion and fire. Do not operate the product in such an environment.  
Also, use in and around a place where a corrosive gas is generated or spreading causes a serious damage to the product. Do not operate the product in such an environment.
- Installation place  
Avoid installing the product on inclined places or on places subject to vibration. Otherwise, the product may slip or fall down to cause damages or injury accidents.

### ■ **Do not let foreign matter in**

Do not insert metal and inflammable materials into the product from its vent and spill water on it. Otherwise, electric shock or fire may occur.

### ■ **Warning item on abnormality while in use**

In abnormal situations, such as “smoke”, “fire”, “abnormal smell” or “irregular noise” occur from the product while in use, stop using the product, turn off the switch, and remove the power cord plug from the outlet. After confirming that no other devices catch fire, ask us or your local dealer.

# USING THE PRODUCT SAFELY

## Warning Item for the Measurement

- When you measure a part of a high voltage, be careful not to touch a hand to a measurement part directly. There is a risk of an electric shock.
- Be sure to connect the probe or the cable and the ground side of the input connector to the ground potential (ground) of the substance measured. Since the chassis of this instrument is connected to the ground of the input block, connecting the earth lead of the probe to the potential floating from the ground potential may result in the following:
  - Electric shock
  - A high current flows and damages the substance measured, this instrument, and other connected device.

The following parts are connected to the chassis:

- Probe for each channel and ground side of the input BNC connector
- Grounding conductor of the accessory 3-core power cord
- Ground pin for an interface signal

“Bad example”

**Prohibition**

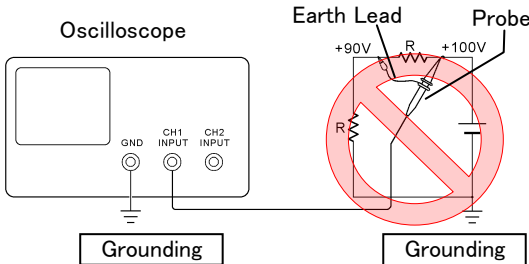

At connecting as Bad Example, +90V and chassis are shorted, and damages substance a measured. Therefore do not make such connection.

If the instrument is not grounded, a potential of the chassis is +90V.

Ground a chassis, in order to prevent an electric shock accident.

When measuring the floating potential, a differential method of measurement is recommended ( refer to the figure below ).

“Good example”

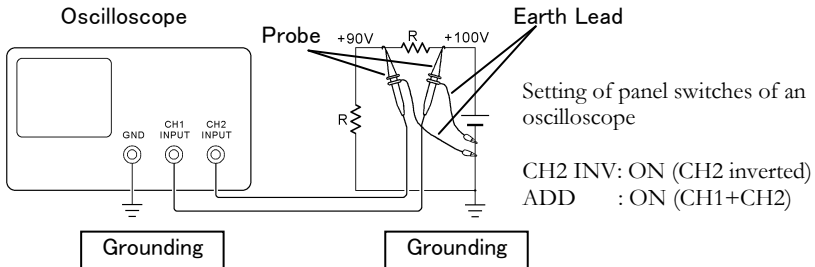

---

---

## USING THE PRODUCT SAFELY

---

---

### ■ Input / Output terminals

Maximum input to terminal is specified to prevent the product from being damaged. Do not supply input, exceeding the specifications that are indicated in the "Rating" column in the instruction manual of the product.

Also, do not supply power to the output terminals from the outside. Otherwise, a product failure is caused.

### ■ Calibration

Although the performance and specifications of the product are checked under strict quality control during shipment from the factory, they may be deviated more or less by deterioration of parts due to their aging or others. It is recommended to periodically calibrate the product so that it is used with its performance and specifications stable.

For consultation about the product calibration, ask us or your local dealer.

### ■ Daily Maintenance

When you clean off the dirt of the product covers, panels, and knobs, avoid solvents such as thinner and benzene. Otherwise, the paint may peel off or resin surface may be affected.

To wipe off the covers, panels, and knobs, use a soft cloth with neutral detergent in it. During cleaning, be careful that water, detergent, or other foreign matters do not get into the product.

If a liquid or metal gets into the product, an electric shock and fire are caused. During cleaning, remove the power cord plug from the outlet.

Use the product correctly and safely, observing the above warning and caution items. Because the instruction manual indicates caution items even in individual items, observe those caution items to correctly use the product.

If you have questions or comments about the instruction manual, ask us or E-Mail us.

# 1. GETTING STARTED

The Getting started chapter introduces the oscilloscope's main features, appearance, and set up procedure.



## 1-1. Main Features

Model name	Frequency bandwidth	Input channels
DCS-4605	DC – 50MHz (–3dB)	2
Performance	<ul style="list-style-type: none"><li>• 250MS/s real-time sampling rate</li><li>• 25GS/s equivalent-time sampling rate</li><li>• Up to 10ns peak detection</li><li>• 2mV~10V vertical scale</li><li>• 1ns ~ 50s time scale</li></ul>	

- 
- Features
- 5.7 inch color TFT display
  - Saving and recalling setups and waveforms
  - 19 automatic measurements
  - Multi-language menu (12 languages)
  - Math operation: Addition, Subtraction, FFT
  - Data logging
  - Go-NoGo testing
  - Edge, video, pulse width trigger
  - Compact size: (W) 310 x (D) 140 x (H) 142 mm

- 
- Interface
- USB 2.0 full-speed interface for saving and recalling data
  - Calibration output
  - External trigger input
  - USB slave interface for remote control

## 1-2. Panel Overview

### 1-2-1. Front Panel

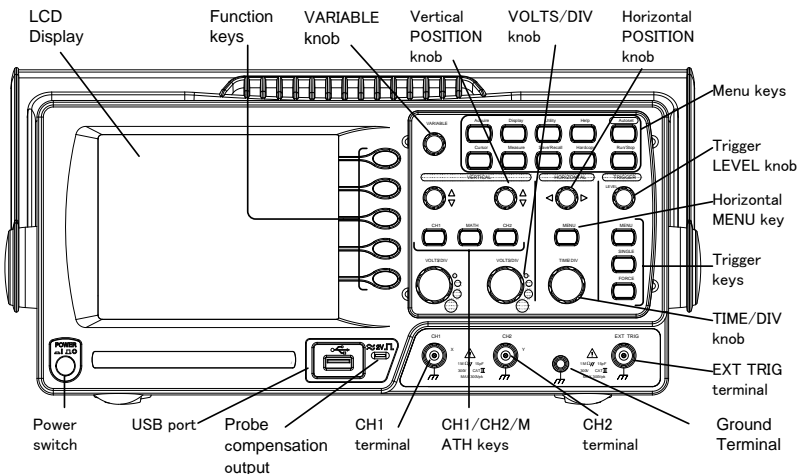



---

**LCD display**      TFT color, 320 x 234 resolution, wide angle view LCD display.

---

**Function keys:**            Activates the functions which appear in the left side of the LCD display.  
 F1 (top) to  
 F5 (bottom)

---

**Variable knob**      **VARIABLE**            Increases or decreases values and moves to the next or previous parameter.

---

**Acquire key**            **Acquire**      Configures the acquisition mode (page 54).













---



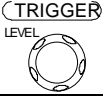







**Display key**            **Display**      Configures the display settings (page 56).

---

**Cursor key**            **Cursor**      Runs cursor measurements (page 39).

---

Utility key		Configures the Hardcopy function (page 83), shows the system status (page 77), selects the menu language (page 77), runs the self calibration (page 93), configures the probe compensation signal (page 94),
Help key		Shows the Help contents on the display (page 28).
Autoset key		Automatically configures the horizontal, vertical, and trigger settings according to the input signal (page 30).
Measure key		Configures and runs automatic measurements (page 36).
Save/Recall key		Saves and recalls images, waveforms, or panel settings (page 78).
Hardcopy key		Stores images, waveforms, or panel settings to USB (page 83).
Run/Stop key		Runs or stops triggering (page 31).
Trigger level knob		Sets the trigger level (page 65).
Trigger menu key		Configures the trigger settings (page 65).
Single trigger key		Selects the single triggering mode (page 70).
Trigger force key		Acquires the input signal once regardless of the trigger condition at the time (page 70).
Horizontal menu key		Configures the horizontal view (page 58).
Horizontal position knob		Moves the waveform horizontally (page 58).

TIME/DIV knob		Selects the horizontal scale (page 59).
Vertical position knob		Moves the waveform vertically (page 62).
CH1/CH2 key		Configures the vertical scale and coupling mode for each channel (page 62).
VOLTS/DIV knob		Selects the vertical scale (page 62).
Input terminal		Accepts input signals: $1M\Omega \pm 2\%$ input impedance, BNC terminal.
Ground terminal		Accepts the DUT ground lead to achieve a common ground.
MATH key		Performs math operations (page 41).
USB port		Facilitates transferring waveform data, display images, and panel settings (page 78).
Probe compensation output		Outputs a 2Vp-p, square signal for compensating the probe (page 94) or demonstration.
External trigger input		Accepts an external trigger signal (page 65).
Power switch		Powers the oscilloscope on or off.

## 1-2-2. Rear Panel

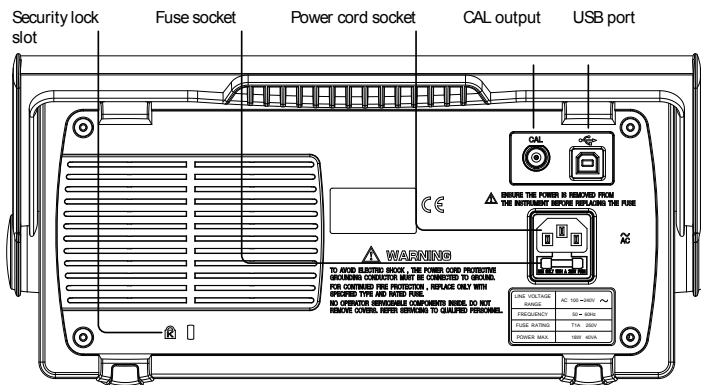

Power cord socket

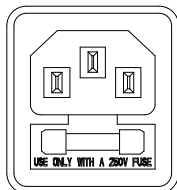

Power cord socket accepts the AC mains, 100 ~ 240V, 50/60Hz.

Fuse socket

The fuse socket holds the AC main fuse, T1A/250V.

For the fuse replacement procedure, see page 96.

USB slave port

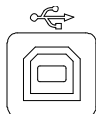

Accepts a type B (slave) male USB connector for remote control of the oscilloscope (page 70).

Calibration output



Outputs the calibration signal used in vertical scale accuracy calibration (page 93).

Security lock slot



Standard laptop security lock slot for ensuring the security.

### 1-2-3. Display

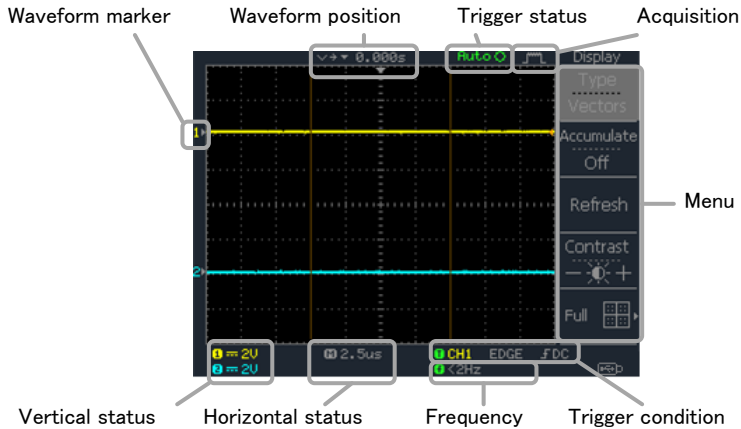

Waveforms	Channel 1: Yellow	Channel 2: Blue
Trigger status	Trig'd Trig? Auto STOP	A signal is being triggered Waiting for a trigger condition Updating the input signal regardless of trigger conditions Triggering is stopped
Input signal frequency	Updates the input signal frequency (the trigger source signal) in real-time. “< 2Hz” Indicates that the signal frequency is less than the lower frequency limit (2Hz) and thus not accurate.	
Trigger configuration	Shows the trigger source, type, and slope. In case of the Video trigger, shows the trigger source and polarity.	
Horizontal status Vertical status	Shows the channel configurations: coupling mode, vertical scale, and horizontal scale.	

## 1-3. Setting up the Oscilloscope

---

**Background** This section describes how to set up the oscilloscope properly including adjusting the handle, connecting a signal, adjusting the scale, and compensating the probe. Before operating the oscilloscope in a new environment, run these steps to make sure the oscilloscope is functionally stable.

---

### Procedure

1. Pull both bases of the handle out slightly.

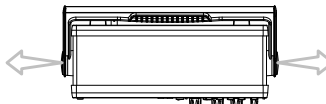

2. Turn to one of the three preset positions.

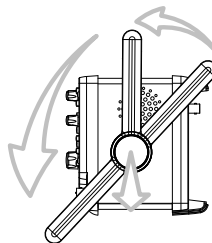

3. Connect the power cord.

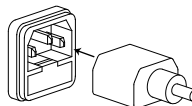

4. Press the power switch. The display will become active in approximately 10 seconds.



5. Reset the system by recalling the factory settings. Press the Save/Recall key, then *Default Setup*. For details regarding the factory settings, see page 27.



6. Connect the probe between the Channel1 input terminal and probe compensation signal output (2Vp-p, 1kHz square wave).

7. Set the probe attenuation voltage to x10.

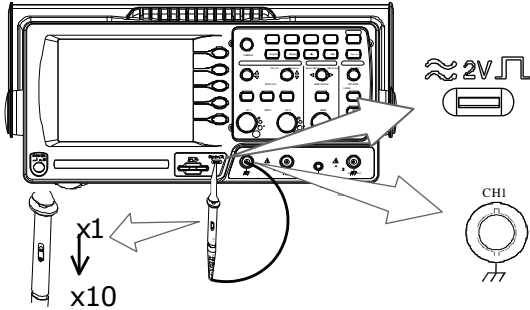

8. Press the Autoset key. A square waveform will appear in the center of the display. For details on Autoset, see page 30.



9. Press the Display key, then *Type* and select the vector waveform type.

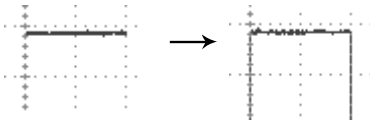
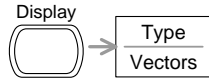

10. Turn the adjustment point on the probe to flatten the square waveform edge.

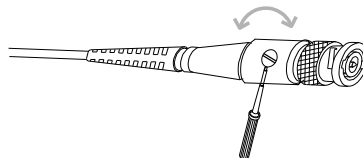
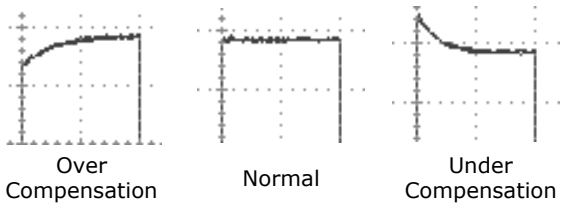

11. Setting up the oscilloscope is complete. You may continue with the other operations.



Measurement: page 29 Configuration: page 54

## 2. QUICK REFERENCE

This chapter lists the oscilloscope menu tree, operation shortcuts, built-in help coverage, and default factory settings. Use this chapter as a handy reference to access the oscilloscope functions.

### 2-1. Menu Tree and Shortcuts

---

Conventions	Examples
Normal	= Press the functional key for “Normal”
Average 	= Repeatedly press the functional key for “Average”
Normal ~ Average	= Select a menu from “Normal” to “Average” and press its functionality key
Normal → VAR 	= Press the functionality key for “Normal”, and then use the Variable knob

#### 2-1-1. Acquire key

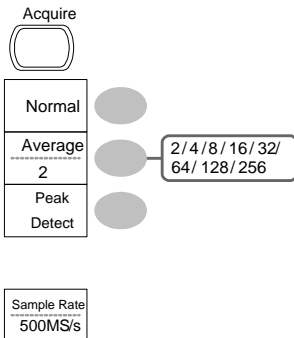













Select acquisition mode

Normal ~ Peak-Detect











Select average number

Average 

### 2-1-2. CH1/CH2 key

CH1 		Turn channel on/off CH 1/2 
Coupling 	   	Select coupling mode Coupling 
Invert Off	 On/Off	Invert waveform
BW Limit Off	 On/Off	Invert 
Probe x1	 X1/x10/x100	Turn bandwidth limit on/off BW Limit 
		Select probe attenuation x1 / x10 / x100

### 2-1-3. Cursor key 1/2

Cursor 		Turn cursor on/off Cursor 
Source CH1	 CH1/ 2/ MATH	Move X1 cursor X1 → VAR 
X1 -5.000uS 0.000uV		Move X2 cursor X2 → VAR 
X2 5.000uS 0.000uV		Move both X1 and X2 cursor X1X2 → VAR 
X1X2 A : 10.00uS F : 100.0kHz 0.000uV		Switch to Y cursor X ↔ Y
X ↔ Y		

## 2-1-4. Cursor key 2/2

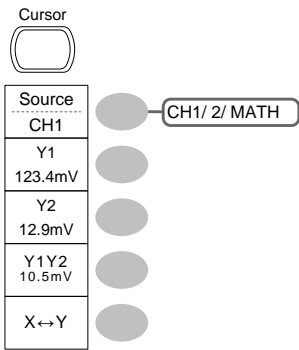

Turn cursor on/off

Cursor

Move Y1 cursor

Y1 → VAR

Move Y2 cursor

Y2 → VAR

Move both Y1 and Y2 cursor

Y1Y2 → VAR

Switch to X cursor

X↔Y

## 2-1-5. Display key

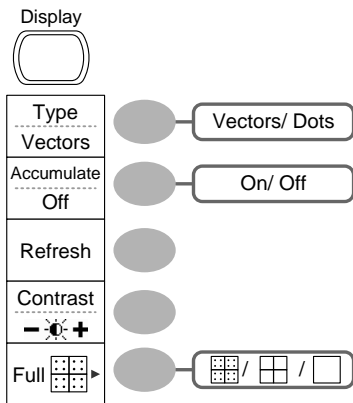

Select waveform type

Type

Waveform accumulate On/Off

Accumulate

Refresh accumulation

Refresh

Set display contrast

Contrast → VAR

Select display grid

### 2-1-6. Autoset key

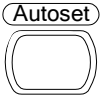

Automatically find the signal and set the scale  
Autoset

### 2-1-7. Hardcopy key



→ See Utility key (page 23)

### 2-1-8. Help key



Turn help mode on/off  
Help ↩

### 2-1-9. Horizontal menu key



Main
Window
Window Zoom
Roll
XY



Select main (default) Main display

Select window mode Window → TIME/DIV 

Zoom in window mode Window Zoom

Select window roll mode Roll

Select XY mode XY

## 2-1-10. Math key 1/2 (+/-)

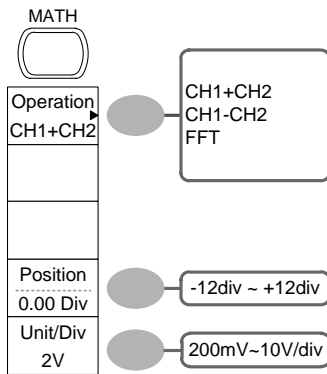

Math on/off

Math  $\leftarrow$

Select math operation type (+/-  
/FFT)

Operation  $\leftarrow$

Set result position

Position  $\rightarrow$  VAR  $\odot$

Math result Volt/Div

Unit/Div  $\rightarrow$  VAR  $\odot$

## 2-1-11. Math key 2/2 (FFT)

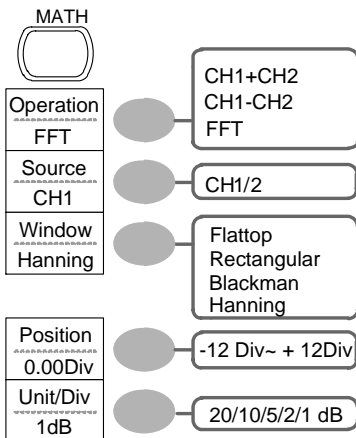

Math on/off

Math  $\leftarrow$

Select math operation type (+/-  
/FFT)

Operation  $\leftarrow$

Select FFT source channel

Source  $\leftarrow$

Select FFT window

Window  $\leftarrow$

Select FFT result position

Vertical  $\rightarrow$  VAR  $\odot$

Select vertical scale

Unit/Div  $\leftarrow$

## 2-1-12. Measure key

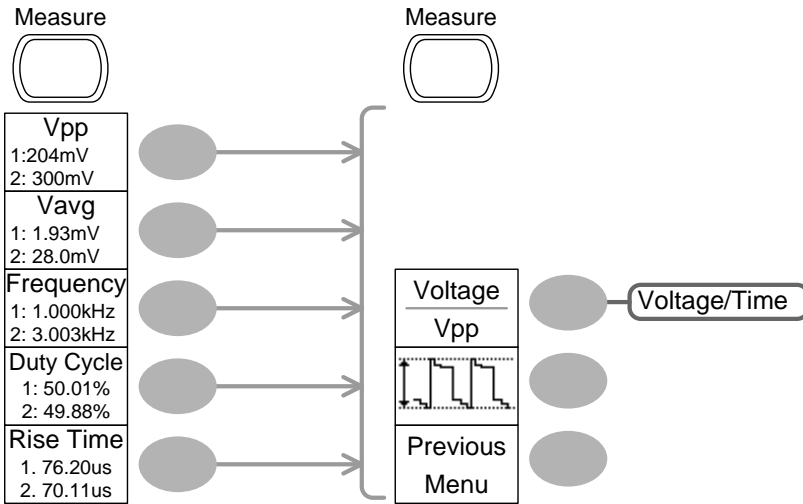

Turn on/off measurement

Measure

Select measurement type

Voltage/Time/Delay

Select measurement item

VAR or Icon(F3) → VAR

Go back to previous menu

Previous Menu

## 2-1-13. Run/Stop key

Run/Stop



Freeze/unfreeze waveform or trigger

Run/Stop

## 2-1-14. Save/Recall key 1/9

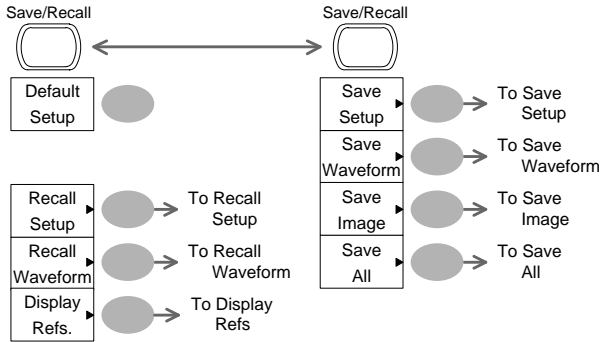

Switch to Save or Recall menu **Save/Recall** ↩

Recall default setup **Default Setup**

## 2-1-15. Save/Recall key 2/9

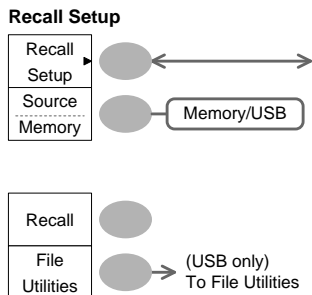

Select other menu

**Recall Setup** ↩

Select setup source

**Source** ↩ → VAR ○

Recall setup

**Recall**

Go to USB file utilities

**File Utilities**

### 2-1-16. Save/Recall key 3/9

#### Recall Waveform

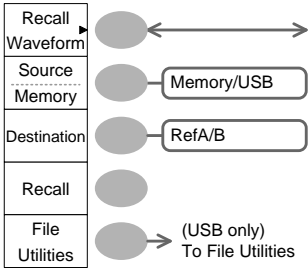

Select other menu

Recall Waveform  $\leftarrow$

Select waveform source

Source  $\leftarrow$   $\rightarrow$  VAR  $\odot$

Select waveform destination

Destination  $\rightarrow$  VAR  $\odot$

Recall waveform

Recall

Go to USB file utilities

File Utilities

### 2-1-17. Save/Recall key 4/9

#### Display Refs.

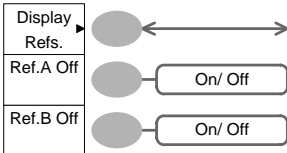

Select other menu

Display Refs.  $\leftarrow$

Turn ref. waveform A on/off

Ref.A  $\leftarrow$

Turn ref. waveform B on/off

Ref.B  $\leftarrow$

### 2-1-18. Save/Recall key 5/9

#### Save Setup

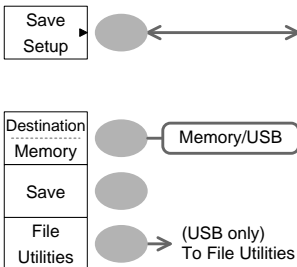

Select other menu

Save Setup  $\leftarrow$

Select destination

Destination  $\leftarrow$   $\rightarrow$  VAR  $\odot$

Save setup

Save

Go to USB file utilities

File Utilities

## 2-1-19. Save/Recall key 6/9

### Save Waveform

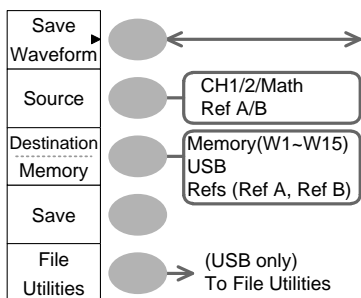

Select other menu

Save Waveform  $\leftarrow$

Select source

Source  $\leftarrow$   $\rightarrow$  VAR  $\odot$

Select destination

Destination  $\leftarrow$   $\rightarrow$  VAR  $\odot$

Save waveform

Save

Go to USB file utilities

File Utilities

## 2-1-20. Save/Recall key 7/9

### Save Image

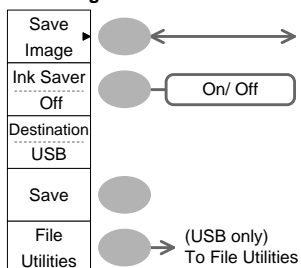

Select other menu

Save Image  $\leftarrow$

Turn on/off ink saver

Ink Saver  $\leftarrow$

Save image

Save

Go to USB file utilities

File Utilities

2-1-21. Save/Recall key 8/9

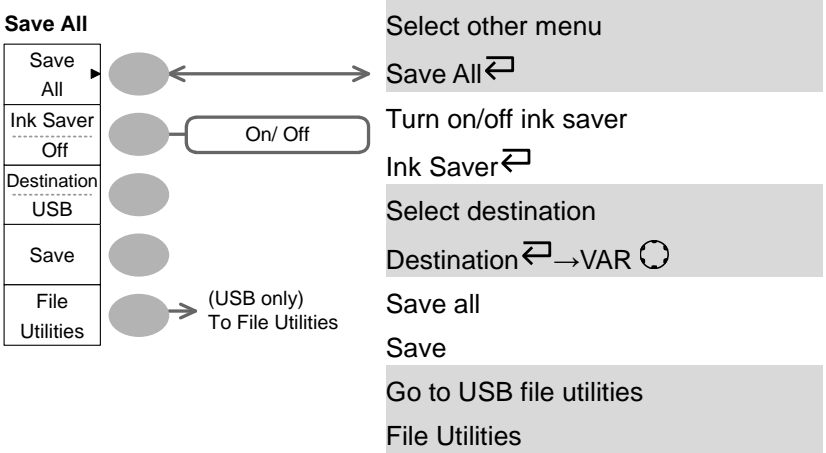

2-1-22. Save/Recall key 9/9

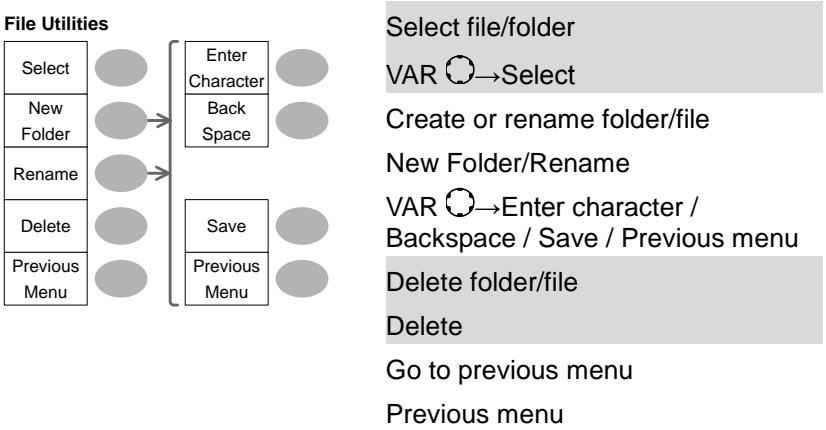

## 2-1-23. Trigger key 1/5

### Trigger Type

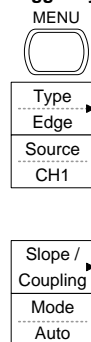

Select Trigger type

Type ↩

## 2-1-24. Trigger key 2/5

### Video Trigger

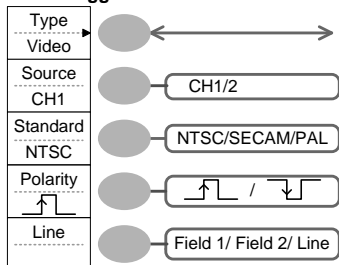

Select video trigger type

Type ↩

Select trigger source

Source ↩

Select video standard

Standard ↩

Select video polarity

Polarity ↩

Select video field/line

Line ↩ → VAR ⦿

### 2-1-25. Trigger key 3/5

#### Edge Trigger

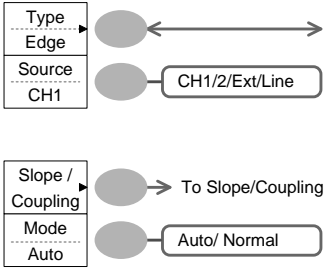

Select edge trigger type

Edge ↩

Select trigger source

Source ↩

Go to slope/coupling menu (page 23)

Slope/Coupling

Select trigger mode

Mode ↩

### 2-1-26. Trigger key 4/5

#### Pulse Trigger

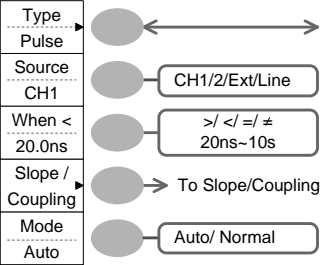

Select pulse trigger type

Type ↩

Select trigger source

Source ↩

Select pulse trigger condition and pulse width

When ↩ → VAR ○

Go to slope/coupling menu (page 23)

Slope/Coupling

Select trigger mode

Mode ↩

## 2-1-27. Trigger key 5/5

### Coupling/Slope

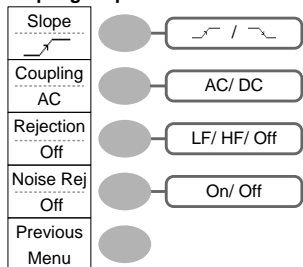

Select trigger slope type

Slope ↵

Select trigger coupling mode

Coupling ↵

Select frequency rejection

Rejection ↵

Turn noise rejection on/off

Noise Rej ↵

Go back to previous menu

Previous Menu

## 2-1-28. Utility key 1/10 (Utility #1)

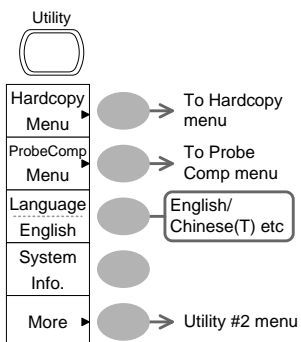

Go to hardcopy menu

Hardcopy

Go to probe compensation menu

ProbeComp

Select language

Language ↵

Show system information

System Info.

Go to the next Utility menu

More

### 2-1-29. Utility key 2/10 (Utility #2)

#### Utility

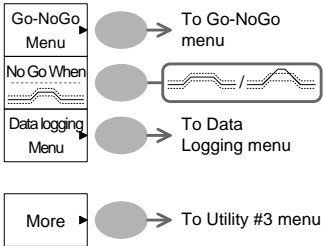

Go to the Go-NoGo menu

Go-NoGo

Set the NoGo conditions to inside /outside limits

No Go When ↩

Go to the Data Logging Menu

Data Logging

Go to the next Utility menu

More

### 2-1-30. Utility key 3/10 (Utility #3)

#### Calibration



Enter self calibration

Self CAL

Go to the first Utility menu



More

### 2-1-31. Utility key 4/10 (Hardcopy -Save All)

#### Hardcopy

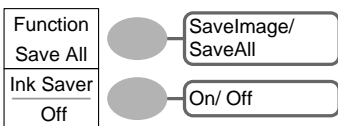

Select Hardcopy function

Function ↩

Turn on/off Ink saver

Ink Saver ↩

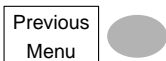

Go to previous menu

Previous Menu ↩

## 2-1-32. Utility key 5/10 (Hardcopy -Save Image)

### Hardcopy- Save Image

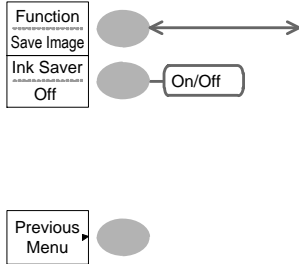

Select Hardcopy function

Function  $\leftarrow$

Turn on/off Inksaver

Ink Saver  $\leftarrow$

Go to previous menu

Previous Menu  $\leftarrow$

## 2-1-33. Utility key 6/10 (Probe compensation)

### Probe compensation

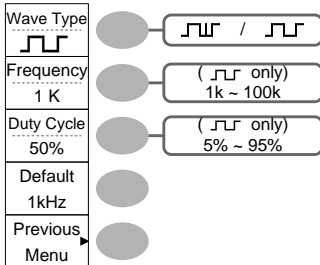

Select probe compensation signal

Wave Type  $\leftarrow$

Set frequency for square wave

Frequency  $\rightarrow$  VAR  $\odot$

Set duty cycle for square wave

Duty Cycle  $\rightarrow$  VAR  $\odot$

Go to previous menu

Previous Menu

## 2-1-34. Utility key 7/10 (Go-NoGo)

### Edit

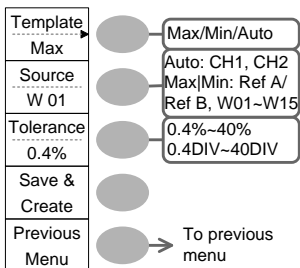

Switch between templates

Template  $\leftarrow$

Select the template source

Source  $\leftarrow$

Set the tolerance (% or Divisions)

Tolerance  $\leftarrow$   $\rightarrow$  VAR  $\odot$

Save the template

Save & Create

Go back to previous menu

Previous Menu

### 2-1-35. Utility key 8/10 (Data Logging 1/2)

#### Data logging

Data logging Off	●	On/Off
Source CH1	●	CH1/CH2
Setup	● →	To the Edit menu
File Utilities	● →	(USB only) To File Utilities
Previous Menu	● →	To previous menu

Turn Data Logging On/Off

Data logging ←

Set the logging source

Source ←

Go to the Data Logging Edit menu  
Setup

Go to the File Utilities menu

File Utilities

Go back to previous menu

Previous Menu

### 2-1-36. Utility key 9/10 (Data Logging 2/2)

#### Edit

Save Waveform	●	Waveform/Image
Interval 2 secs	●	2 secs~30 mins
Duration 5 mins	●	5 mins~100 hrs
Previous Menu	● →	To previous menu

Save the logs as waveform data or as image files

Save ←

Set the logging interval

Interval → VAR ⌚

Set the duration of the record log

Duration → VAR ⌚

Go back to previous menu

Previous Menu

### 2-1-37. Utility key 10/10 (Self CAL Menu)

#### Self Cal.

Vertical	● →	Start Vertical Calibration
----------	-----	----------------------------



Start Vertical Calibration

Vertical

## 2-1-38. Default Settings

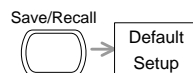
Here are the factory installed panel settings which appear when pressing the Save/Recall key→ *Default Setup.*



Acquisition	Mode: Normal	
Channel	Scale: 2V/Div	Invert: Off
	Coupling: DC	Probe attenuation voltage: x1
	BW limit: Off	Channel 1 & 2: On
Cursor	Source: CH1	Cursor: Off
Display	Type: Vectors	Accumulate: Off
	Grid: Full 	
Horizontal	Scale: 2.5us/Div Hor Pos: 0	Mode: Main Timebase
Math	Type: + (Add) Unit/Div: 2V	Position: 0.00 div
Measure	Item: Vpp, Vavg, Frequency, Duty Cycle, Rise Time	
Trigger	Type: Edge	Source: Channel1
	Mode: Auto	Slope: 
	Coupling: DC	Rejection: Off
	Noise Rejection: Off	
Utility	Hardcopy: Savelmage, InkSaver off	ProbeComp: Square wave, 1k, 50% duty cycle
Go-NoGo	Go-NoGo: Off	Source: CH1
	When: 	Violating: Stop
Data Logging	Data logging: Off	Source: CH1
	Setup: Waveform	Interval: 2 secs
	Duration: 5 mins	

## 2-2. Built-in Help

---

The Help key shows the contents of the built-in help support. When you press a function key, its descriptions appear in the display.



Applicable keys

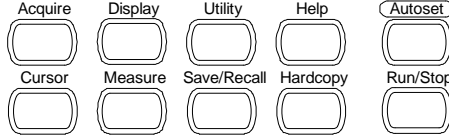

(Vertical)

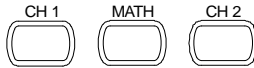

(Horizontal) (Trigger)

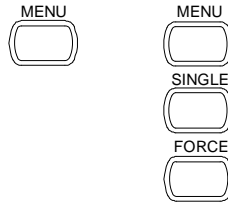

Procedure

1. Press the Help key. The display changes to the Help mode.



2. Press a functional key to access its help contents. (example: Acquire key)



3. Use the Variable knob to scroll the Help contents up and down.



4. Press the Help key again to exit the Help mode.



### 3. MEASUREMENT

The Measurement chapter describes how to properly observe a signal using the oscilloscope's basic functions, and how to observe a signal in a detailed manner using some of the advanced functions such as: Automatic measurements, cursor measurements, and math operations.

#### 3-1. Basic Measurements

This section describes the basic operations required in capturing and viewing an input signal. For more detailed operations, see the following chapters.

- Measurements → from page 29
- Configuration → from page 54

##### 3-1-1. Activating a channel

Activating a channel

To activate an input channel, press the Channel key, CH1 or CH2. The channel indicator appears at the left side of the display and the channel icon changes accordingly.

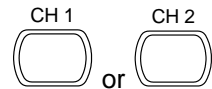

Channel 1 off

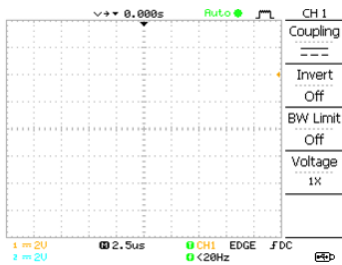

Channel 1 on

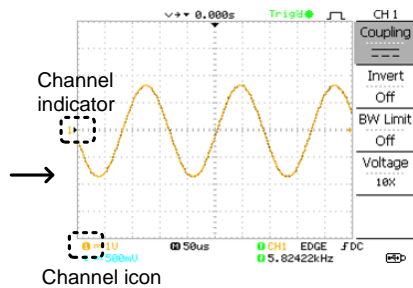

De-activating a channel

To de-activate the channel, press the Channel key twice (once if the channel menu is already selected).

### 3-1-2. Using Autoset

**Background** The Autoset function automatically configures the panel settings to the best viewing conditions, in the following way.

- Selecting the horizontal scale
- Positioning the waveform horizontally
- Selecting the vertical scale
- Positioning the waveform vertically
- Selecting the trigger source channel
- Activating the channels

**Procedure**

1. Connect the input signal to the oscilloscope and press the Autoset key. 
2. The waveform(s) appears in the center of the display.

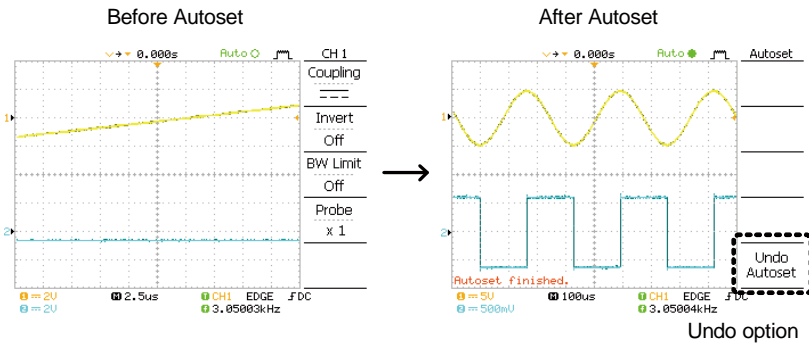

**Undoing the Autoset** To undo the Autoset, press *Undo* (available for a few seconds).

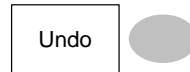

**Adjusting the trigger level** If the waveform is still unstable, try adjusting the trigger level up or down by using the Trigger Level knob. 

**Limitation** Autoset does not work in the following situation.

- Input signal frequency less than 30Hz
- Input signal amplitude less than 30mV

### 3-1-3. Running and stopping the trigger

**Background** In the trigger Run mode, the oscilloscope constantly searches for a trigger condition and updates the signal onto the display when the condition is met.

In the trigger Stop mode, the oscilloscope stops triggering and thus the last acquired waveforms stay in the display. The trigger icon at the top of the display changes into Stop mode.

Pressing the Trigger Run/Stop key switches between the Run and Stop mode.

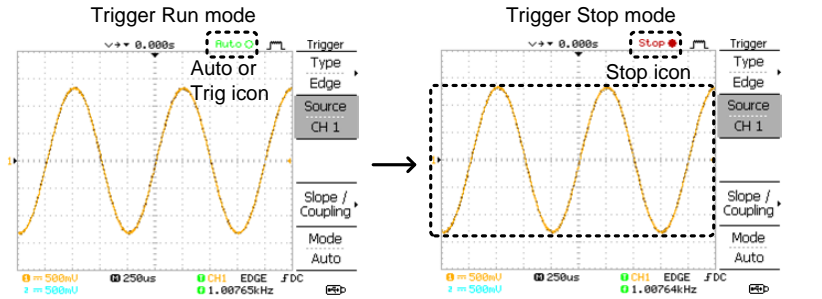

**Waveform operation**

Waveforms can be moved or scaled in both the Run and Stop mode. For details, see page 58 (Horizontal position/scale) and page 62 (Vertical position/scale).

### 3-1-4. Changing the horizontal position and scale

For more detailed configurations, see page 58.

Setting the horizontal position

The horizontal position knob moves the waveform left or right.



The position indicator moves along with the waveform and the distance from the center point is displayed as the offset in the upper side of the display.

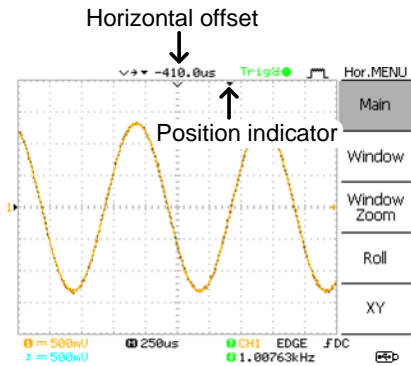

Selecting the horizontal scale

To select the timebase (scale), turn the TIME/DIV knob; left (slow) or right (fast).



Range 1ns/div ~ 10s/div, 1-2.5-5 increment

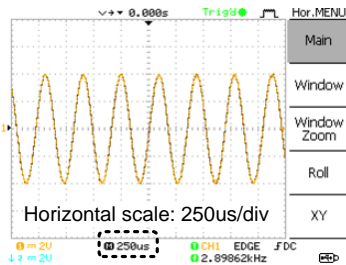
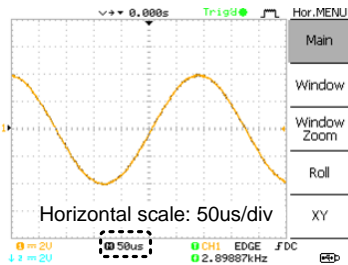

### 3-1-5. Changing the vertical position and scale

For more detailed configuration, see page 62.

---

Set vertical position

To move the waveform up or down, turn the vertical position knob for each channel.



As the waveform moves, the vertical position of the cursor appears at the bottom left corner of the display.

Run/Stop mode The waveform can be moved vertically in both Run and Stop mode.

---

Select vertical scale

To change the vertical scale, turn the VOLTS/DIV knob; left (down) or right (up).



Range 2mV/div ~ 10V/div, 1-2-5 increments

The vertical scale indicator for each channel on the bottom left of the display changes accordingly.

### 3-1-6. Using the probe compensation signal

#### Background

This section introduces how to use the probe compensation signal for general usage, in case the DUT signal is not available or to get a second signal for comparison. For probe compensation details, see page 94.



Note: The frequency accuracy and duty factor are not guaranteed. Therefore the signal should not be used for reference purposes.

#### Waveform type



Square waveform used for probe compensation. 1k ~ 100kHz, 5% ~ 95%.



Demonstration signal for showing the effects of peak detection. See page 54 for peak detection mode details.

#### View the probe compensation waveform

1. Connect the probe between the compensation signal output and Channel input.

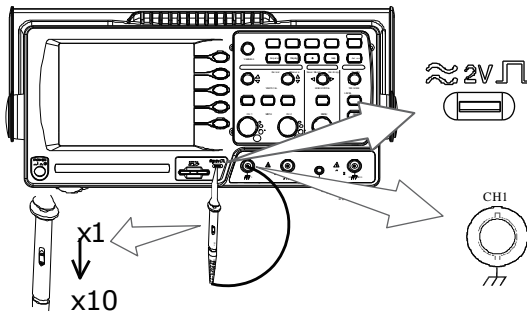

2. Press the Utility key.



3. Press *ProbeComp*.

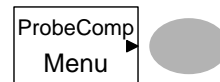

4. Press Wave type repeatedly to select the wave type.

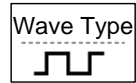

5. (For  $\square$  only) To change the frequency, press *Frequency* and use the Variable knob.

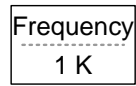

VARIABLE



Range 1kHz ~ 100kHz

6. (For  $\square$  only) To change the duty cycle, press *Duty Cycle* and use the Variable knob.

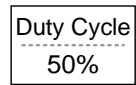

VARIABLE



Range 5% ~ 95%

---

Probe  
compensation





For probe compensation details, see page 94.

### 3-2. Automatic Measurements

The automatic measurement function measures input signal attributes and updates them in the display. Up to 5 automatic measurement items can be updated at any one time on the side menus. All automatic measurement types can be displayed on screen if necessary.







#### 3-2-1. Measurement items

Overview	Voltage type	Time type
	Vpp	Frequency
	Vmax	Period
	Vmin	RiseTime
	Vamp	FallTime
	Vhi	+Width
	Vlo	-Width
	Vavg	Dutycycle
	Vrms	
	ROVShoot	
	FOVShoot	
	RPREShoot	
	FPREShoot	
Voltage measurement items	Vpp	Difference between positive and negative peak voltage (=Vmax - Vmin)
	Vmax	Positive peak voltage.
	Vmin	Negative peak voltage.
	Vamp	Difference between global high and global low voltage (=Vhi - Vlo)
	Vhi	Global high voltage.
	Vlo	Global low voltage.
	Vavg	Averaged voltage of the first cycle.

Vrms		RMS (root mean square) voltage.
ROVShoot		Rise overshoot voltage.
FOVShoot		Fall overshoot voltage.
RPREShoot t		Rise preshoot voltage.
FPREShoot t		Fall preshoot voltage.

---

Time measurement items

Freq		Frequency of the waveform.
Period		Waveform cycle time (=1/Freq).
Risetime		Rising time of the pulse (~90%).
Falltime		Falling time of the pulse (~10%).
+Width		Positive pulse width.
-Width		Negative pulse width.
Duty Cycle		Ratio of signal pulse compared with whole cycle =100x (Pulse Width/Cycle)

### 3-2-2. Automatically measuring the input signals

Viewing the measurement result

1. Press the Measure key.



2. The measurement results appear on the menu bar, constantly updated. 5 measurement slots (F1 to F5) can be customized.

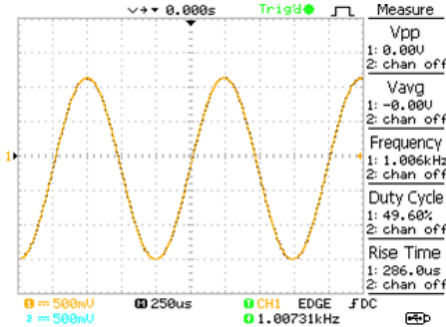

Selecting a measurement item

3. Press F3 repeatedly to select the measurement type: Voltage or Time.

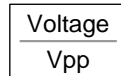

4. Use the Variable knob to select the measurement item.

VARIABLE

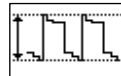

5. Press Previous Menu to confirm the item selection and to go back to the measurement results view.

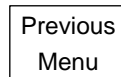

### 3-3. Cursor Measurements

Cursor lines, horizontal or vertical, show the precise position of the input waveforms or the math operation results. The horizontal cursors can track time, voltage/current\* and frequency, whilst the vertical cursors can track voltage/current\*. All measurements are updated in real-time. \*probe type dependant (page 64).

#### 3-3-1. Using the horizontal cursors

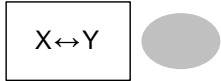
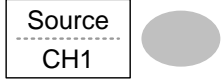
Procedure	1. Press the Cursor key. The cursors appear in the display.	
	2. Press X↔Y to select the horizontal (X1&X2) cursor.	
	3. Press Source repeatedly to select the source channel.	
	4. The cursor measurement results will appear in the menu, F2 to F4.	Range CH1, 2, MATH

Parameters	X1	Time position of the left cursor. (relative to zero)
	X2	Time position of the right cursor. (relative to zero)
	X1X2	The difference between the X1 and X2.
	Δ: us	The time difference between X1 and X2.
	f: Hz	The time difference converted to frequency.
	V/A	The voltage/current difference from X1 and X2.
	M1:dB	Position of the left cursor in dB.
	M2:dB	Position of the right cursor in dB.
Δ: dB	The dB difference between M1 and M2.	
Div:	The frequency per division.	

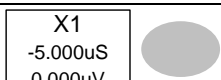
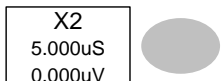
Moving the horizontal cursors	To move the left cursor, press X1 and then use the Variable knob.	
	To move the right cursor, press X2 and then use the Variable knob.	

To move both cursors at once, press  $X1X2$  and then use the Variable knob.

X1X2  
 $\Delta$  : 10.00uS  
 $f$  : 100.0kHz  
 0.000uV



Remove cursors Press Cursor to remove the onscreen cursors.



### 3-3-2. Using the vertical cursors

Procedure	1. Press the Cursor key.	Cursor	
	2. Press $X\leftrightarrow Y$ to select the vertical (Y1&Y2) cursor.	$X\leftrightarrow Y$	
	3. Press <i>Source</i> repeatedly to select the source channel.	Source ----- CH1	
	Range CH1, 2, MATH		
	4. The cursor measurement results will appear in the menu.		

Parameters	Y1	Voltage level of the upper cursor
	Y2	Voltage level of the lower cursor
	Y1Y2	The difference between the upper and lower cursor
	V/A	The voltage/current difference (Y1-Y2).

Moving the vertical cursors	To move the upper cursor, press $Y1$ and then use the Variable knob.	Y1 123.4mV	
	To move the lower cursor, press $Y2$ and then use the Variable knob.	Y2 12.9mV	
	To move both cursors at once, press $Y1Y2$ and then use the Variable knob.	Y1Y2 10.5mV	

Remove cursors Press Cursor to remove the onscreen cursors.



### 3-4. Math Operations

The Math operations can add, subtract, multiply or perform FFT on the input waveforms. The resulted waveform can be measured using the cursors, and saved or recalled just like normal input signals.

#### 3-4-1. Overview

---

Addition (+)	Adds the amplitude of CH1 & CH2 signals.	
Subtraction (-)	Extracts the amplitude difference between CH1 & CH2.	
FFT	Performs a FFT calculation on a signal. Four types of FFT windows are available: Hanning, Flattop, Rectangular, and Blackman.	
Hanning FFT window	Frequency resolution	Good
	Amplitude resolution	Not good
	Suitable for....	Frequency measurement on periodic waveforms
Flattop FFT window	Frequency resolution	Not good
	Amplitude resolution	Good
	Suitable for....	Amplitude measurement on periodic waveforms
Rectangular FFT window	Frequency resolution	Very good
	Amplitude resolution	Bad
	Suitable for....	Single-shot phenomenon (this mode is the same as having no window at all)
Blackman FFT window	Frequency resolution	Bad
	Amplitude resolution	Very good
	Suitable for....	Amplitude measurement on periodic waveforms

### 3-4-2. Adding, subtracting or multiplying signals

---

Procedure

1. Activate both CH1 and CH2.

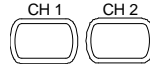

2. Press the Math key.



3. Press *Operation* repeatedly to select addition (+), subtraction (-) or multiplication (x).

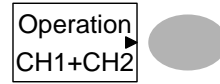

4. The math measurement result appears in the display.





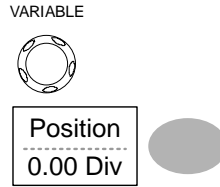







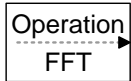

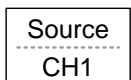
5. To move the math result vertically, use the Variable knob. The position will be displayed in *Position*.

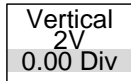

6. To clear the math result from the display, press the Math key again.

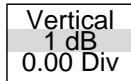

### 3-4-3. Using the FFT function

- |  |   |   |   |
|--|---|---|---|
| Procedure  | 1. Press the Math key.  |  |   |
|  | 2. Press <i>Operation</i> repeatedly to select FFT.   |  |  |
|  | 3. Press <i>Source</i> repeatedly to select the source channel.   |  |  |
|  | 4. Press <i>Window</i> repeatedly to select the FFT window type.  |  |  |
|  | 5. The FFT result appears. The horizontal scale changes from time to frequency, and the vertical scale from voltage to dB.                          |   |   |
|  | 6. To move the FFT waveform vertically, press <i>Vertical</i> repeatedly until Div is selected. Use the Variable knob to change the vertical scale. |  |  |
|  |   |  |   |
|  | Range      -12.00 div ~ +12.00 div  |   |   |
| 7. To select the vertical scale of an <i>FFT waveform</i> , press <i>Vertical</i> repeatedly until dB is selected. Use the Variable knob to change the vertical scale. |    |  |   |
|  |   |   |   |
| Range      1, 2, 5, 10, 20 dB/Div  |   |   |   |
| 8. To clear the FFT result from the display, press the Math key again.   |    |   |   |

## 3-5. Go No-Go Testing

### 3-5-1. Overview

Background	Go-NoGo testing checks if a waveform conforms to a user-specified maximum and minimum boundary (template). The testing can be set to stop or continue each time the template has or has not been violated by the input waveform.		
Settings	Item	Default	Details
	NoGo criteria: When inside or outside the boundary	Inside	Page 44
	Source	Channel 1	Page 45
	Test continue or stop when NoGo occurs	Stop	Page 45
	Boundary (template) – selects the minimum and maximum boundaries (template) from a single waveform	Auto (0.4%)	Page 46
Run Tests			Page 50

### 3-5-2. Edit: NoGo When

Procedure 1. Press the Utility key.



2. Press the *More* key.



3. Press *No Go When* repeatedly to select the NoGo conditions.

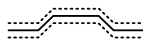
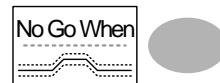

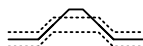

NoGo when the waveform is inside the boundary (template)



NoGo when the waveform is outside of the boundary (template)



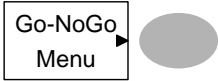
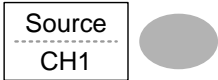

### 3-5-3. Edit: Source

---

Procedure	1. Press the Utility key.	
	2. Press the <i>More</i> key.	
	3. Press the <i>Go-NoGo Menu</i> key.	
	4. Press <i>Source</i> repeatedly to select the source channel (CH1 or CH2).	

### 3-5-4. Edit: NoGo Violation Conditions

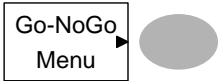
---

Procedure	1. Press the Utility key.	
	2. Press the <i>More</i> key.	
	3. Press the <i>Go-NoGo Menu</i> key.	
	4. Press <i>Violating</i> repeatedly to select the NoGo conditions.	

Stop      Stops the test when the NoGo conditions have been met.

Continue      The tests continue even when the NoGo conditions have been met.

### 3-5-5. Edit: Template (boundary)

---

#### Background

The NoGo template sets the upper and lower amplitude boundary. Two methods are available: Min/Max and Auto.

**Min/Max** Selects the upper boundary (Max) and lower boundary (Min) as separate waveforms, from the internal memory. The upper boundary is saved to Ref A, the lower boundary is saved to Ref. B.

Advantage: The template shape and distance (allowance) between the source signal are fully customizable.

Disadvantage: The waveforms (templates) have to be stored internally prior to this selection.

**Auto** Creates the upper and lower boundary (template) from the source signal, not from an internally stored waveform.

Advantage: No need to store the waveforms prior to this selection.

Disadvantage: The template shape is proportional to the source signal. The distance (allowance) between the source signal and the upper and lower template is the same.

---

#### Max/Mix

1. The template is based on the source signal. Ensure the source signal appears on the display.
2. Press the Utility key.



3. Press the *More* key.



4. Press the *Go-NoGo Menu* key.

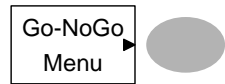

5. Press the *Template Edit* key.



6. Press *Template* repeatedly to select the upper (Max) or lower (Min) boundaries.

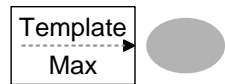

7. Press *Source* and use the Variable knob to select the waveform template.

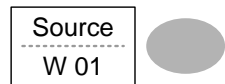

VARIABLE



Max            Waveform A: Ref A, W01~W15

Min            Waveform B: Ref B, W01~W15

8. Press *Position* and use the Variable knob to set the waveform amplitude.

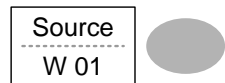

VARIABLE



9. Repeat steps 5-7 for the other template setting (Max or Min).

10. When both Max and Min templates have been configured, press *Save & Create* to save the templates.



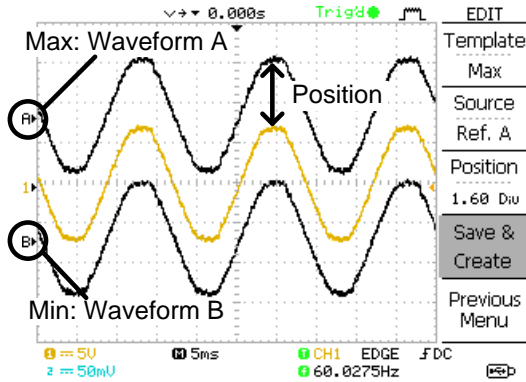

Auto

1. The template is based on the source signal. Ensure the source signal appears on the display.

2. Press the Utility key.



3. Press the *More* key.



4. Press the *Go-NoGo Menu* key.

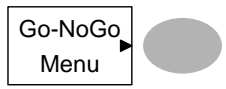

5. Press the *Template Edit* key.

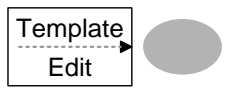

6. Press *Template* repeatedly to select the Auto template.

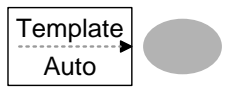

7. Press *Source* and use the Variable knob to select the template source.

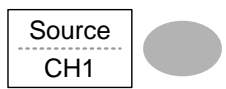

VARIABLE



Source CH1, CH2

8. Press *Tolerance* repeatedly to choose the tolerance units, % or Div. Use the Variable knob to set the tolerance. The tolerance is for both the horizontal and vertical axis.

Tolerance  
0.4%

VARIABLE



% 0.4% ~ 40.0%  
Div 0.04 div ~ 4.0 div

9. When the Auto template has been configured, press *Save & Create* to save the template.

Save &  
Create

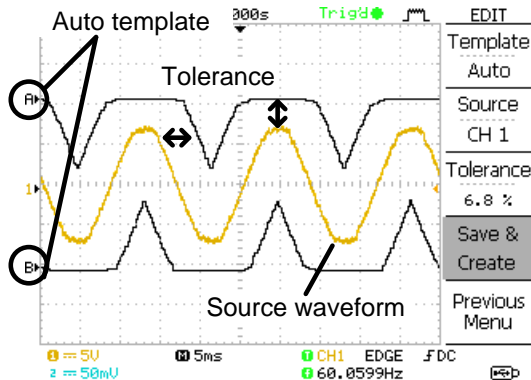

### 3-5-6. Run Go-NoGo Tests

---

Procedure

1. Press the Utility key.



2. Press the *More* key.



3. Press the *Go-NoGo Menu* key.

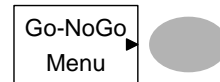

Ensure the source signal and boundary templates appear on the screen.

4. Press *Go-NoGo*. The test starts and stops according to the conditions set on page 44, 45. To stop the test that has already started, press *Go-NoGo* again.

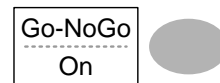

5. The test results appear in the Ratio soft-key. The numerator denotes the total number of failed tests. The denominator denotes the total number of tests.

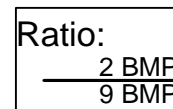

Numerator      Number of "failed" tests.

Denominator    Total number of tests.

## 3-6. Data Logging

### 3-6-1. Overview

---

**Background** The Data logging function allows you to log data or a screen image over timed intervals for up to 100 hours to a USB flash drive.



The data or images are stored to a USB flash drive in a directory named LogXXXX. LogXXXX is incremented each time the data logging function is used.

The files saved in the LogXXXX directory are named DSXXXX.CSV, or DSXXXX.BMP for data or image files, respectively. At each timed interval data or an image file is saved and the file number incremented. For example, DS0000 is the first logged data, DS0001 is the second and so on.

---





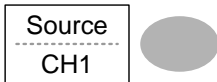

### 3-6-2. Edit: Source

---

- |                  |  |   |
|------------------|--|---|
| <b>Procedure</b> | 1. Press the Utility key.  |    |
|                  | 2. Press the <i>More</i> key.  |    |
|                  | 3. Press the <i>Data logging Menu</i> key.                                   |   |
|                  | 4. Press <i>Source</i> repeatedly to select the source channel (CH1 or CH2). |  |

### 3-6-3. Edit: Setup Parameters

**Background** The logging function must set the type of data that will be logged (waveform/image), the capture interval time and the duration of the data logging.

- Procedure**
1. Press the *Utility* key.
 
  2. Press the *More* key.
 
  3. Press the *Data logging Menu* key.
 
  4. Press the *Setup* key.
 
  5. Press *Save* repeatedly to log data or screen images.
 
  6. Press *Interval* and use the Variable knob to select the interval time.
 

VARIABLE

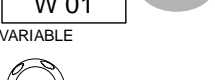
Interval	2 secs~ 2min (duration = 5 min)
time	2 secs~ 5 min (duration 5~ 30 min)
	2 secs~ 30 min (duration 30+ min)
  7. Press *Duration* and use the Variable knob to set the duration time.
 



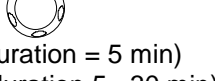

VARIABLE

Duration	5 mins ~ 100 hours
----------	--------------------
  8. Press *Previous* menu to return to the *Data logging* menu. *Data logging* is now ready to begin.
 

### 3-6-4. Run Data logging

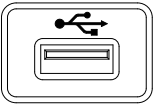
---

**Background**      Ensure the data source (page 51) and data logging setup has been set (page 52).

- Procedure**
1. Insert a USB flash drive into the USB front panel port. 
  2. Press the Utility key. 
  3. Press the *More* key. 
  4. Press the *Data logging Menu* key. 
  5. Press *Data logging* to turn data logging On. Data/image files start logging to the USB flash drive automatically. To stop the Data logging, press the *Data logging* key again. 

## 4. CONFIGURATION

The Configuration chapter describes how to configure panel settings to make measurements and observations suited to the application needs.

### 4-1. Acquisition

The acquisition process samples the analog input signals and converts them into digital format for internal processing. You may select the normal, average, or peak detect acquisition mode.

#### 4-1-1. Selecting the acquisition mode

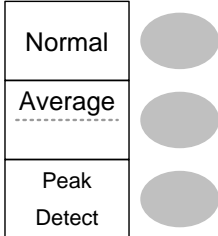
Procedure	1. Press the Acquire key.	Acquire
	2. Select the acquisition mode between <i>Normal</i> , <i>Average</i> and <i>Peak Detect</i> .	
Range	Normal	All of the acquired data is used to draw the waveform.
	Average	Multiple data is averaged to form a waveform. This mode is useful for drawing a noise-free waveform. To select the number, press <i>Average</i> repeatedly. Average number: 2, 4, 8, 16, 32, 64, 128, 256
	Peak detect	To activate the Peak detect mode, press <i>Peak-Detect</i> . Only the minimum and maximum value pairs for each acquisition interval (bucket) are used. This mode is useful for catching abnormal glitches in a signal.

Peak detect effect using the probe comp. waveform

1. One of the probe compensation waveforms can demonstrate the peak detection mode. Connect the probe to the probe compensation output.
2. Press the Utility key.
3. Press *ProbeComp*.
4. Press *Wave Type* and select the  $\square\sqcup$  waveform.
5. Press the Autoset key. The oscilloscope positions the waveform in the center of the display.
6. Press the Acquire key.
7. Press *Normal*.
8. Press *Peak-Detect* and see that a spike noise is captured.

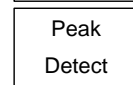
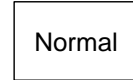
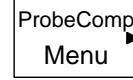

Example

The peak detect mode reveals the occasional glitch.

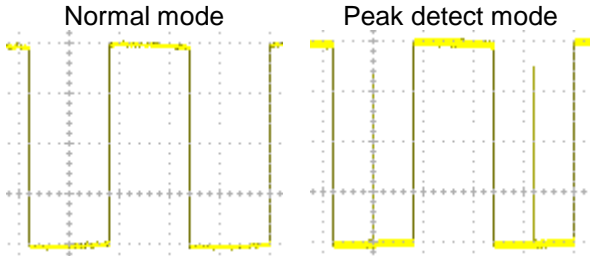

## 4-1-2. Real time vs Equivalent time sampling mode

---



Background	The oscilloscope automatically switches between two sampling modes, Real-time and Equivalent-time, according to the number of active channels and sampling rate.
Real-time sampling	Once sampled data is used to reconstruct a single waveform. Short-time events might get lost if the sampling rate gets too high. This mode is used when the sampling rate is relatively low (250MS/s or lower).
Equivalent-time sampling	Multiple numbers of sampled data are accumulated to reconstruct a single waveform. ETS restores more waveform detail but takes longer to update the waveform. This mode is used when the sampling rate becomes higher than 250MS/s. The maximum equivalent-time sampling rate is 25GSa/s.

## 4-2. Display

The Display section describes how to configure the display settings: drawing type, waveform accumulation, contrast adjustment, and grid settings.

### 4-2-1. Selecting vector or dot drawing

---

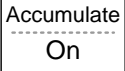
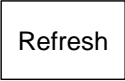

Procedure	9. Press the Display key.	
	10. Press <i>Type</i> repeatedly to select the waveform drawing.	
Types	Dots	Only the sampled dots are displayed.
	Vectors	The sampled dots are connected by lines.

## 4-2-2. Accumulating the waveform

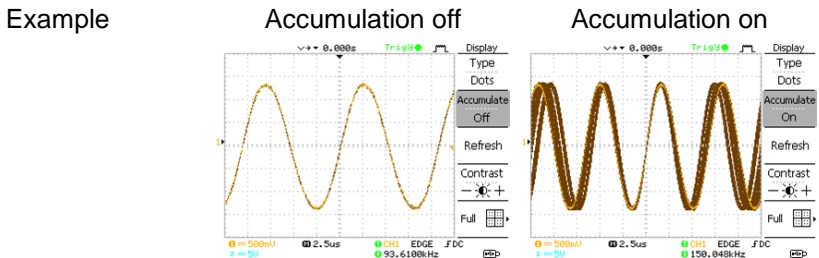
Background	Accumulation preserves the old waveform drawings and overwrites new waveforms on top of it. It is useful for observing waveform variation.
Procedure	<ol style="list-style-type: none"> <li>1. Press the Display key. </li> <li>2. Press <i>Accumulate</i> to turn on the waveform accumulation. </li> <li>3. To clear the accumulation and start it over (refresh), press <i>Refresh</i>. </li> </ol>



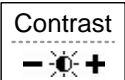

## 4-2-3. Adjusting the display contrast

Procedure	<ol style="list-style-type: none"> <li>1. Press the Display key. </li> <li>2. Press <i>Contrast</i>. </li> <li>3. Turn the Variable knob left to lower the contrast (dark display) or right to raise the contrast (bright display). </li> </ol>
-----------	--

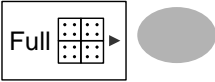
#### 4-2-4. Selecting the display grid

- Procedure
1. Press the Display key. 
  2. Press the grid icon repeatedly to select the grid. 

- Parameters
-  Shows the full grid.
  -  Shows the outer frame and X/Y axis.
  -  Shows only the outer frame.

#### 4-3. Horizontal View

The Horizontal view section describes how to configure the horizontal scale, position, waveform update mode, window zoom, and X-Y mode.

##### 4-3-1. Moving the waveform position horizontally

- Procedure
- The horizontal position knob moves the waveform left or right. The position indicator at the top of the display shows the center and current position.
- 



### 4-3-2. Selecting the horizontal scale

Select horizontal scale To select the timebase (scale), turn the TIME/DIV knob; left (slow) or right (fast).



Range 1ns/div ~ 50s/div, 1-2.5-5-10 increment

The timebase indicator at the bottom of the display updates the current horizontal scale.



### 4-3-3. Selecting the waveform update mode

Background The display update mode is switched automatically or manually according to the horizontal scale.

Main mode Updates the whole displayed waveform at once. The main mode is automatically selected when the horizontal scale (timebase) is fast.

Horizontal scale  $\leq 100\text{ms/div}$

Trigger All modes available

Roll mode Updates and moves the waveform gradually from the right side of the display to the left. The Roll mode is automatically selected when the horizontal scale (timebase) is 50ms or slower.



Timebase  $\geq 50\text{ms/div}$  ( $\leq 1.25\text{MS/s}$ )

Trigger Auto mode only

Selecting the Roll mode manually

1. Press the Horizontal menu key.



2. Press *Roll*. The horizontal scale automatically becomes 50ms/div and the waveform starts scrolling from the right side of the display (If the oscilloscope is already in the Roll mode, there will be no change).



#### 4-3-4. Zooming the waveform horizontally

---

Procedure/  
range

1. Press the Horizontal Menu key.



2. Press *Window*.



3. Use the horizontal position knob to move the zoom range sideways, and TIME/DIV knob to change the zoom range width.

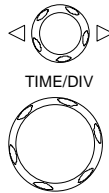

The width of the bar in the middle of the display is the actual zoomed area.

Zoom range 1ns ~ 25s

4. Press *Window Zoom*. The specified range gets zoomed.



## Example

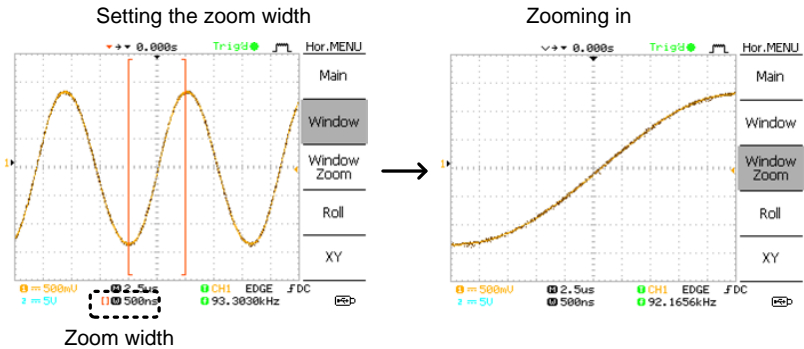

### 4-3-5. Viewing waveforms in the X-Y mode

**Background** The X-Y mode compares the voltage of Channel 1 and Channel 2 waveforms in a single display. This mode is useful for observing the phase relationship between the two waveforms.

#### Procedure

1. Connect the signals to Channel 1 (X-axis) and Channel 2 (Y-axis).

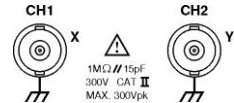

2. Make sure both Channel 1 and 2 are activated.

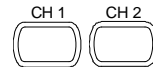

3. Press the Horizontal key.



4. Press XY. The display shows two waveforms in X-Y format; Channel 1 as X-axis, Channel 2 as Y-axis.



Adjusting the X-Y mode waveform	Horizontal position	CH1 Position knob
	Horizontal scale	CH1 VOLTS/DIV knob
	Vertical position	CH2 Position knob
	Vertical scale	CH2 VOLTS/DIV knob

## Example

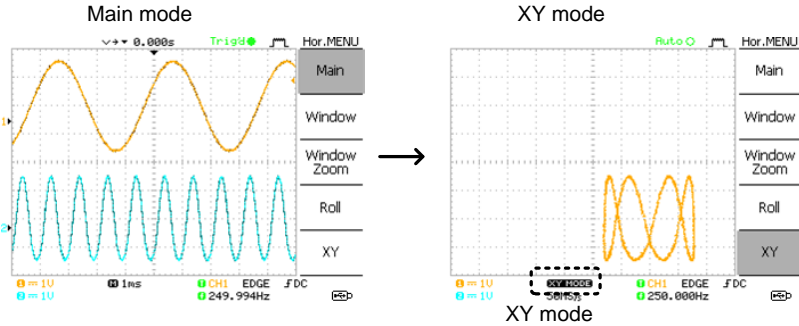

### 4-4. Vertical View (Channel)

The Vertical view section describes how to set the vertical scale, position, bandwidth limitation, coupling mode, and attenuation.

#### 4-4-1. Moving the waveform position vertically

**Procedure** To move the waveform up or down, turn the vertical position knob for each channel. 



#### 4-4-2. Selecting the vertical scale

**Procedure** To change the vertical scale, turn the VOLTS/DIV knob; left (down) or right (up). 

**Range** 2mV/div ~ 10V/div, 1-2-5 increments

#### 4-4-3. Selecting the coupling mode

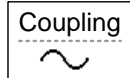
**Procedure**

1. Press the Channel key. 
2. Press *Coupling* repeatedly to select the coupling mode.  

**Range**  DC coupling mode. The whole portion (AC and DC) of the signal appears on the display.



Ground coupling mode. The display shows only the zero voltage level as a horizontal line. This mode is useful for measuring the signal amplitude with respect to the ground level.



AC coupling mode. Only the AC portion of the signal appears on the display. This mode is useful for observing AC waveforms mixed with DC components.

#### 4-4-4. Inverting the waveform vertically

Procedure

1. Press the Channel key.



2. Press *Invert*. The waveform becomes inverted (upside down) and the Channel indicator in the display shows a down arrow.

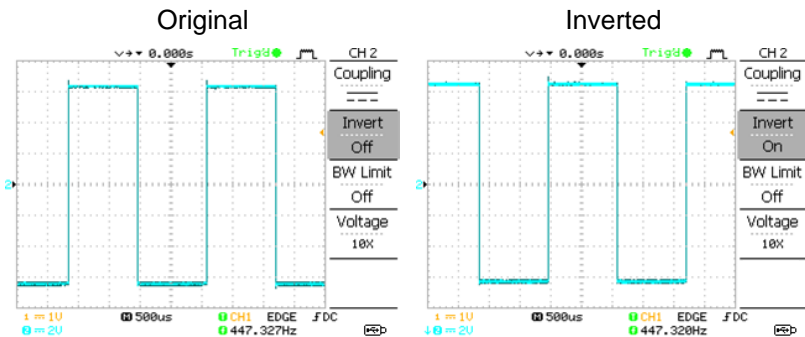
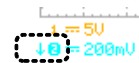
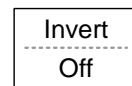

#### 4-4-5. Limiting the waveform bandwidth

**Background** Bandwidth limitation puts the input signal into a 20MHz (-3dB) low-pass filter. This function is useful for cutting off high frequency noise to see the clear waveform shape.

**Procedure**

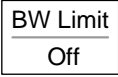
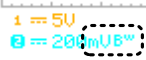

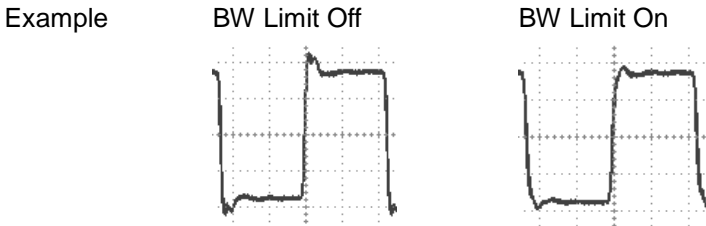
1. Press the Channel key. 
2. Press *BW Limit* to turn on or off the limitation. When turned on, the BW indicator appears next to the Channel indicator in the display.  



#### 4-4-6. Probe attenuation level and type

**Background** A signal probe has an attenuation switch to lower the original DUT signal level to the oscilloscope input range, if necessary. The probe attenuation selection adjusts the vertical scale so that the voltage level on the display reflects the real value, not the attenuated level.

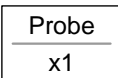
**Procedure**

1. Press the Channel key. 
2. Press Probe repeatedly to select the attenuation level.  

- The voltage scale in the channel indicator changes accordingly. There is no change in the waveform shape.

---

Range	x1, x10, x100
-------	---------------

---



Note: The attenuation factor adds no influence on the real signal; it only changes the voltage/current scale on the display.

## 4-5. Trigger

The Trigger function configures the conditions by which the oscilloscope captures the incoming signals.

### 4-5-1. Trigger type

---

Edge	Triggers when the signal crosses an amplitude threshold in either a positive or negative slope.
Video	Extracts a sync pulse from a video format signal and triggers on a specific line or field.
Pulse	Triggers when the pulse width of the signal matches the trigger settings.

---

Indicators	Edge/Pulse	Video
	(CH1, Edge, Rising edge, DC coupling)	(CH1, Video, Positive polarity, NTSC standard)

### 4-5-2. Trigger parameter

---

Trigger source	CH1, 2	Channel 1, 2 input signals
	Line	AC mains signal
	Ext	External trigger input signal

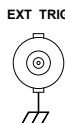











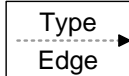

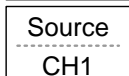

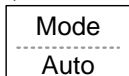

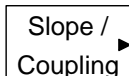

Triggers on the falling edge.

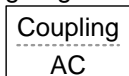
Trigger coupling	AC	Triggers only on AC component.
	DC	Triggers on AC+DC component.
Frequency rejection	LF	Puts a high-pass filter and rejects the frequency below 50kHz.
	HF	Puts a low-pass filter and rejects the frequency above 50kHz.
Noise rejection	Rejects noise signals.	
Trigger level		Using the trigger level knob moves the trigger point up or down.

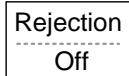
### 4-5-3. Configuring the edge trigger

Procedure	1. Press the Trigger menu key.		
	2. Press <i>Type</i> repeatedly to select edge trigger.		
	3. Press <i>Source</i> repeatedly to select the trigger source.		
	Range Channel 1, 2, Line, Ext		
	4. Press <i>Mode</i> repeatedly to select the Auto or Normal trigger mode. To select the single trigger mode, press the Single key.		
	Range Auto, Normal		
	5. Press <i>Slope/coupling</i> to enter into the trigger slope and coupling selection menu.		
	6. Press <i>Slope</i> repeatedly to select the trigger slope, rising or falling edge.		
Range Rising edge, falling edge			
7. Press <i>Coupling</i> repeatedly to select the trigger coupling, DC or AC.			
Range DC, AC			
8. Press <i>Rejection</i> to select the frequency rejection mode.			
Range LF, HF, Off			

- 9. Press *Noise Rej* to turn the noise rejection on or off.
 

Noise Rej
Off
- Range On, Off
- 10. Press *Previous* menu to go back to the previous menu.
 

Previous
Menu

#### 4-5-4. Configuring the video trigger

- Procedure
- 1. Press the Trigger menu key.
 

MENU
(button icon)
  - 2. Press *Type* repeatedly to select video trigger. The video trigger indicator appears at the bottom of the display.
 

Type
Video
  - 3. Press *Source* repeatedly to select the trigger source channel.
 

Source
CH1
  - Range Channel 1, 2
  - 4. Press *Standard* repeatedly to select the video standard.
 

Standard
NTSC
  - Range NTSC, PAL, SECAM
  - 5. Press *Polarity* repeatedly to select the video signal polarity.
 

Polarity
(polarity icon)
  - Range positive, negative
  - 6. Press *Line* repeatedly to select the video field line. Use the Variable knob to select the field.
 

Line
------



Field NTSC: 1 ~ 262 (Field 2), 1 ~ 263 (Field 1) PAL/SECAM: 1 ~ 312 (Field 2), 1 ~ 313 (Field1)

## 4-5-5. Configuring the pulse width trigger

### Procedure

1. Press the Trigger menu key.



2. Press *Type* repeatedly to select pulse width trigger. The pulse width trigger indicator appears at the bottom of the display.

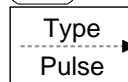

3. Press *Source* repeatedly to select the trigger source.

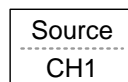

Range Channel 1, 2, Ext

4. Press *Mode* repeatedly to select the trigger mode, Auto or Normal. To select the Single trigger mode, press the Single key.

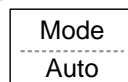

Range Auto, Normal

5. Press *When* repeatedly to select the pulse condition. Then use the Variable knob to set the pulse width.

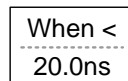

VARIABLE



Condition > , < , = , ≠

Width 20ns ~ 10s

6. Press *Slope/Coupling* to set trigger slope and coupling.

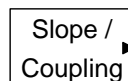

7. Press *Slope* repeatedly to select the trigger slope, which also appears at the bottom of the display.

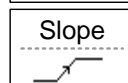

Range Rising edge, falling edge

8. Press *Coupling* repeatedly to select the trigger coupling.

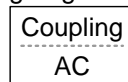

Range DC, AC

9. Press *Rejection* to select the frequency rejection mode.

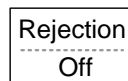

Range LF, HF, Off

10. Press *Noise Rej* to turn the noise rejection on or off.

Noise Rej  
Off



Range On, Off

11. Press *Previous* menu to go back to the previous menu.

Previous  
Menu



#### 4-5-6. Manually triggering the signal

---



Note: This section describes how to manually trigger the input signals when the oscilloscope does not capture them. This section applies to the Normal and Single trigger mode, since in the Auto trigger mode, the oscilloscope keeps updating the input signal regardless of the trigger conditions.

---

To acquire the signal regardless of trigger conditions

To acquire the input signal regardless of the trigger condition, press the Force key. The oscilloscope captures the signals once.

FORCE

In the Single trigger mode

Press the Single key to start waiting for the trigger condition. To break out of the Single mode, press the Run/Stop key. The trigger mode changes to the Normal mode.

SINGLE

Run/Stop

## 4-6. Remote Control Interface

The Remote control interface section describes how to set up the USB interface for PC connection. Remote control command details are described in the DCS-4605 Programming Manual.

---

USB connection	PC end	Type A, host (Windows7 compatible PC only)
	DCS-4605 end	Type B, slave
	Speed	1.1/2.0 (full speed)

---

### Procedure

12. Connect the USB cable to the USB slave port.



13. The USB port may need to be configured if the USB port is not automatically detected.

14. When the PC asks for the USB driver or 'Unknown device' listed in Device Manager, install DCS-4605.inf attached CD.

15. On the PC, activate a terminal application such as Putty. To check the COM port No., see the Device Manager in the PC.

16. Run this query command via the terminal application.

\*idn?

This command should return the manufacturer, model number, serial number, and firmware version in the following format.  
TEXIO, DCS-4605, XXXXXXX, V1.00

17. Configuring the command interface is complete. Refer to the programming manual for the remote commands and other details.



**CAUTION:**

If there is no response, please confirm a device driver, COM port number or the connection of the cable and so on.



**CAUTION:**

If you change the setting of the USB port in the connection with the PC, May not be able to communicate. Please restart your PC in this case.

## 4-7. Control with the “FreeWave”

It is possible to control from PC by using the application the FreeWave attached CD.

It is also possible to control the application by using GUI and the command. For details about commands, see the DCS-4605 programming manual.

---

### 4-7-1. System requirements

OS	Microsoft Windows 7 (32bit/64bit)
Required software	Microsoft .NETFramework ver4.0 full Microsoft Visual C++2010 Redistributable Package

Before you install the FreeWave ,Check the required software by "Control panel > Add or remove program".

Please install required software If you can't find.

You must have administrator account to install software.

This application features and display may change to allow for the upgrade.

### 4-7-2. Icon

Each screen is switched by selecting icon in the upper part of the screen. The function of the button of each icon is as follows.

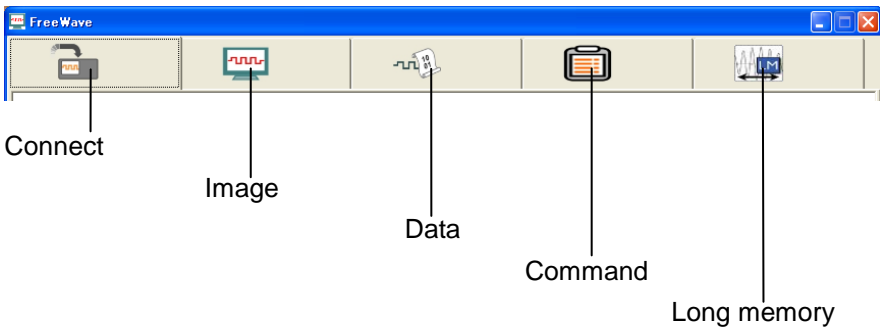

NOTE: Long memory is not work at DCS-4605.

### 4-7-3. Connect screen

It is screen to select the model that controls from the Free Wave.

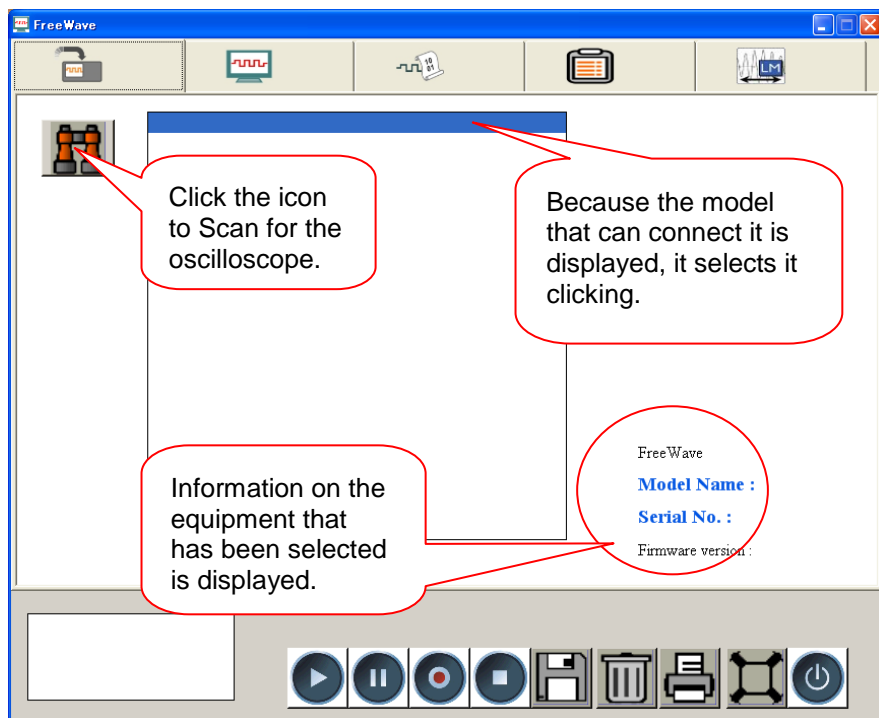

Click the scan icon to Scan for the oscilloscope.

Depending on the environment of the PC may take a minute to startup and update.

#### 4-7-4. Image screen

When the ▶ button under the screen is pushed, the display is in real time displayed.

The displayed image can be preserved as data in the printout and PC.

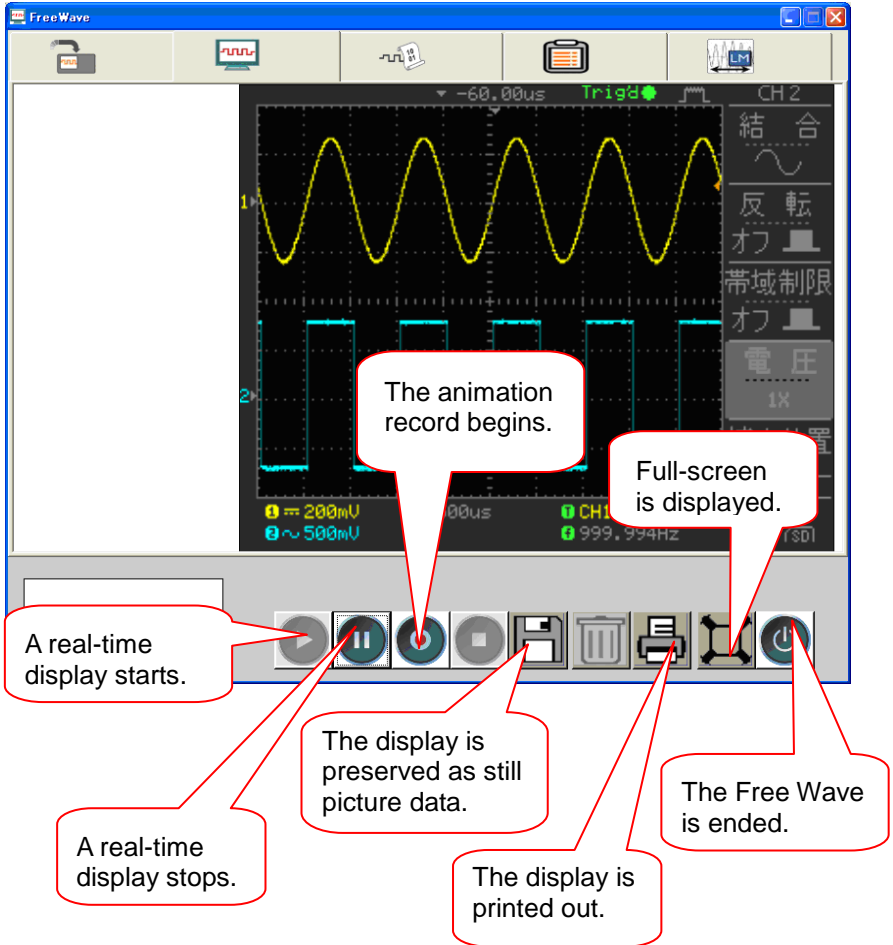

#### 4-7-5. Data screen

When the  button under the screen is pushed, a waveform data (4k/ch) is taken into the Free Wave and displayed.

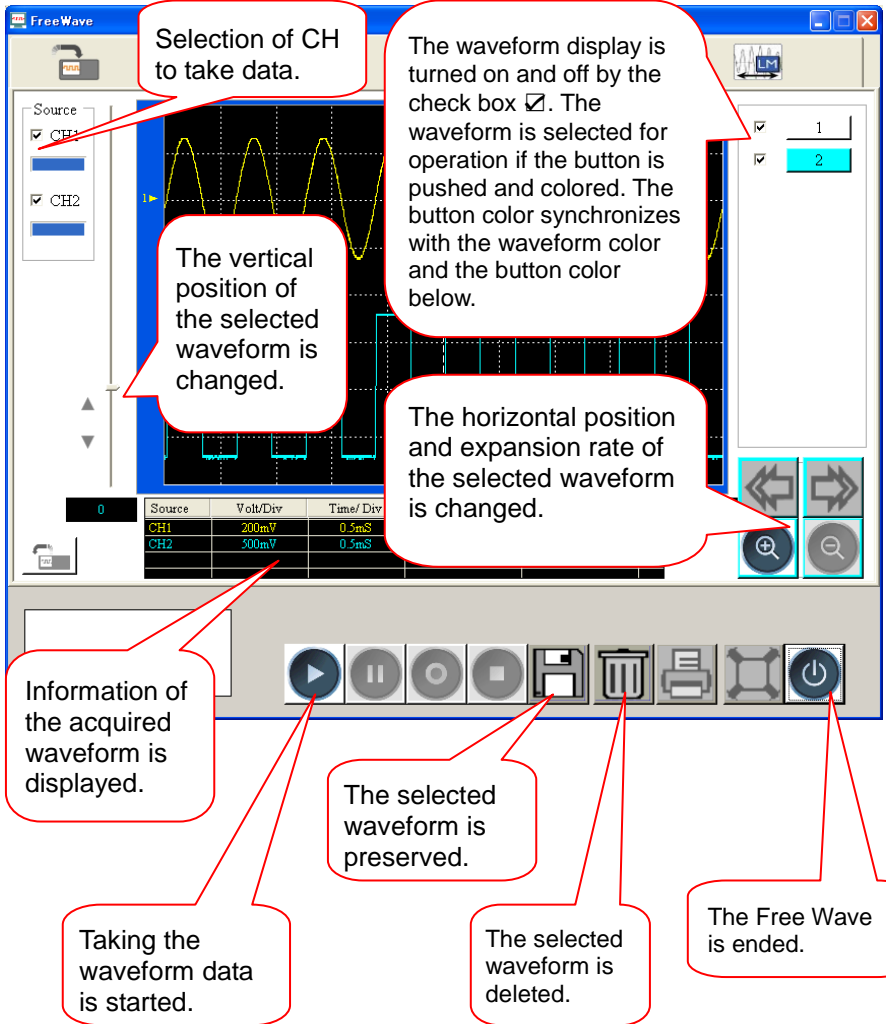

The screenshot shows the FreeWave software interface. The main display area shows two waveforms: a yellow sine wave (CH1) and a blue square wave (CH2). The interface includes a 'Source' panel on the left with checkboxes for CH1 and CH2. A table at the bottom displays the following data:

Source	Volt/Div	Time/Div
CH1	200mV	0.5mS
CH2	500mV	0.5mS

Callouts provide the following information:

- Selection of CH to take data.** (Points to the Source panel)
- The waveform display is turned on and off by the check box . The waveform is selected for operation if the button is pushed and colored. The button color synchronizes with the waveform color and the button color below.** (Points to the CH1 and CH2 checkboxes)
- The vertical position of the selected waveform is changed.** (Points to the vertical slider)
- The horizontal position and expansion rate of the selected waveform is changed.** (Points to the zoom and pan buttons)
- Information of the acquired waveform is displayed.** (Points to the table)
- Taking the waveform data is started.** (Points to the play button)
- The selected waveform is preserved.** (Points to the save button)
- The selected waveform is deleted.** (Points to the trash button)
- The Free Wave is ended.** (Points to the power button)

#### 4-7-6. Command screen

The commands are displayed as the command tree at the left of the screen, and the command list can be made by selecting the command from the tree and moving to the command list in the right of the screen. After the command is listed, the command is sequentially executed from top of the list window when the ▶ button is pushed

The screenshot shows a control interface with a command tree on the left, a command list in the center, and a table on the right. The interface includes various control buttons at the bottom and a status bar at the bottom right.

**Callouts:**



- The command is selected from the command tree, then the ⇒ button is pushed, and the command is moved to the command list of the right window. Because the commands are displayed as a tree, when the + part is clicked, the lower command is displayed.
- The response is displayed in query. Except query, double click and set a setting value.
- The command is selected.
- The command is selected from a right and left table, and moved, or deleted.
- Query or the execution command is selected by double clicking.
- The preserved command list is called.
- The command list is preserved.
- The command list is executed.
- The command list is deleted.
- The Free Wave is ended.

Value	Set/Query
,RJ210...	Query
	Set
	Set
	Query

## 4-8. System Settings

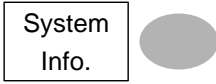

The system settings show the oscilloscope's system information and allow changing the language.

### 4-8-1. Viewing the system information

Procedure	1. Press the Utility key.	
	2. Press <i>System Info</i> . The upper half of the display shows the following information. <ul style="list-style-type: none"><li>• Model</li><li>• Firmware version</li><li>• Serial number</li><li>• Web address</li></ul>	
	3. Press any other key to go back to the waveform display mode.	

### 4-8-2. Selecting the language

Parameter	Language selection differs according to the region to which the oscilloscope is shipped. <ul style="list-style-type: none"><li>• English</li><li>• Chinese (simplified)</li><li>• Korean</li><li>• German</li><li>• Portuguese</li><li>• Polish</li><li>• Chinese (traditional)</li><li>• Japanese</li><li>• French</li><li>• Russian</li><li>• Italian</li><li>• Spanish</li></ul>
-----------	---

Procedure	1. Press the Utility key.	
	2. Press <i>Language</i> repeatedly to select the language.	

## 5. SAVE/RECALL

The save function allows saving display images, waveform data, and panel settings into the oscilloscope's internal memory or to the front panel USB port. The recall function allows recalling the default factory settings, waveform data, and panel settings from the oscilloscope's internal memory or from USB.

### 5-1. File Structures

Three types of file are available: display image, waveform file, and panel settings.

#### 5-1-1. Display image file format

---

Format	xxxx.bmp (Windows bitmap format)
Contents	The current display image in 234 x 320 pixels, color mode. The background color can be inverted (Ink saver function).

#### 5-1-2. Waveform file format

---

Format	xxxx.csv (Comma-separated values format which can be opened in spreadsheet applications such as Microsoft Excel)	
Waveform type	CH1, 2 Math	Input channel signal Math operation result (page 41)
Storage location	Internal memory External USB Flash drive Ref A, B	The oscilloscope's internal memory, which can hold 15 waveforms. A USB flash drive (FAT or FAT32 format) can hold practically an unlimited number of waveforms. Two reference waveforms are used as a buffer to recall a waveform in the display. You have to save a waveform into internal memory or to USB, then copy the waveform into the reference waveform slot (A or B), and then recall the reference waveform into the display.

---

---

Waveform data format

1 division includes 25 points of vertical data. The vertical point starts from the GND level. 1 division includes 250 points of horizontal data. 4000 points in total and each 8div from screen center. At the roll mode, right side of the screen is the final data. If the horizontal scale is 2.5us faster than a small number of points.

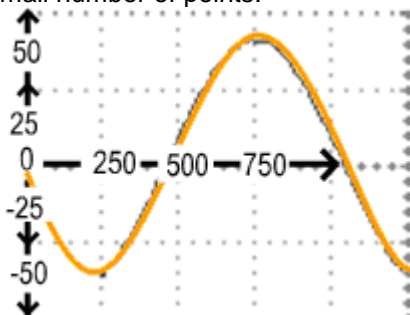

The time or amplitude represented by each data point depends on the vertical and horizontal scale. For example:

Vertical scale: 100mV/div ( 4mV per point)

Horizontal scale: 1ms/div (4us per point)

---

Waveform file contents: other data

A waveform file also includes the following information.

- Memory length
- source channel
- vertical offset
- vertical scale
- coupling mode
- trigger level
- vertical position
- time base
- probe attenuation
- horizontal view
- horizontal scale
- sampling period
- sampling mode

### 5-1-3. Setup file format

Format	xxxx.set (proprietary format) A setup file saves or recalls the following settings.	
Contents	Acquire	<ul style="list-style-type: none"> <li>• mode</li> </ul>
	Cursor	<ul style="list-style-type: none"> <li>• source channel</li> <li>• cursor on/off</li> <li>• cursor location</li> </ul>
	Display	<ul style="list-style-type: none"> <li>• dots/vectors</li> <li>• grid type</li> <li>• accumulation on/off</li> </ul>
	Measure	<ul style="list-style-type: none"> <li>• item</li> </ul>
	Utility	<ul style="list-style-type: none"> <li>• hardcopy type</li> <li>• language</li> <li>• Data Logging settings</li> <li>• ink saver on/off</li> <li>• Go-Nogo settings</li> </ul>
	Horizontal	<ul style="list-style-type: none"> <li>• display mode</li> <li>• position</li> <li>• scale</li> </ul>
	Trigger	<ul style="list-style-type: none"> <li>• trigger type</li> <li>• trigger mode</li> <li>• video polarity</li> <li>• pulse timing</li> <li>• source channel</li> <li>• video standard</li> <li>• video line</li> <li>• slope/coupling</li> </ul>
	Channel (vertical)	<ul style="list-style-type: none"> <li>• vertical scale</li> <li>• coupling mode</li> <li>• bandwidth limit on/off</li> <li>• vertical position</li> <li>• invert on/off</li> <li>• probe attenuation</li> </ul>
	Math	<ul style="list-style-type: none"> <li>• operation type</li> <li>• vertical position</li> <li>• FFT window</li> <li>• source channel</li> <li>• unit/div</li> </ul>

## 5-1-4. Using the USB file utilities

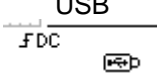
Background	When a USB flash drive is inserted into the oscilloscope, file utilities (file deletion, folder creation and file/folder renaming) are available from the front panel.
Procedure	<ol style="list-style-type: none"> <li>1. Insert a USB flash drive into the front panel USB port.</li> <li>2. Press the Save/Recall key. Select any save or recall function. For example USB Destination in the Save image function.</li> <li>3. Press <i>File Utilities</i>. The display shows the USB flash drive contents.</li> <li>4. Use the Variable knob to move the cursor. Press <i>Select</i> to go into the folder or go back to the previous directory level.</li> </ol>
USB flash drive indicator	<p>When a USB flash drive is inserted into the oscilloscope, an indicator appears at the right bottom corner of the display. (The USB flash drive shouldn't be removed when a file is saved or retrieved from USB).</p> <p style="text-align: center;">USB</p> 
Creating a new folder / renaming a file or folder	<ol style="list-style-type: none"> <li>1. Move the cursor to the file or folder location and press <i>New Folder</i> or <i>Rename</i>. The file/folder name and the character map will appear on the display.</li> </ol>

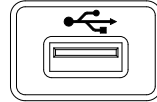

Save/Recall



(Example)

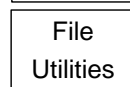

VARIABLE

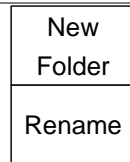
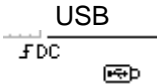
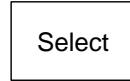

- Use the Variable knob to move the pointer to the characters. Press *Enter Character* to add a character or *Back Space* to delete a character.

VARIABLE

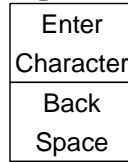

- When editing is complete, press *Save*. The new/renamed file or folder will be saved.





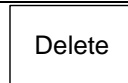

Deleting a folder or file

- Move the cursor to the folder or file location and press *Delete*. The message "*Press F4 again to confirm this process*" appears at the bottom of the display.
- If the file/folder still needs to be deleted, press *Delete* again to complete the deletion. To cancel the deletion, press any other key.

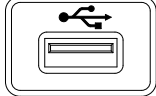

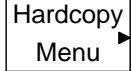
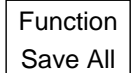
## 5-2. Quick Save (HardCopy)

Background	<p>The Hardcopy key works as a shortcut for printing screen images directly to save display images, waveform data, and panel settings onto a USB flash drive card.</p> <p>The Hardcopy key can be configured into three types of operations: save image, save all (image, waveform, setup)</p> <p>Using the Save/Recall key can also save files with more options. For details, see page 84.</p>	
Functionalities	<p><b>Save image</b> Saves the current display image into (*.bmp)</p> <p><b>Save all</b> Saves the following items into a USB flash drive.</p> <ul style="list-style-type: none"> <li>• Current display image (*.bmp)</li> <li>• Current system settings (*.set)</li> <li>• Current waveform data (*.csv)</li> </ul>	
Procedure	<ol style="list-style-type: none"> <li>1. Insert a USB flash drive into the front panel USB port.</li> <li>2. Press the Utility key.</li> <li>3. Press <i>Hardcopy Menu</i>.</li> <li>4. Press <i>Function</i> repeatedly to select <i>Save Image</i> or <i>Save All</i>.</li> <li>5. To invert the color in the display image, press <i>Ink Saver</i>. This turns Ink Saver on or off.</li> <li>6. Press the Hardcopy key. The file or folder will be saved to the root directory of the USB flash drive.</li> </ol>	     

## 5-3. Save

This section describes how to save data using the Save/Recall menu.

### 5-3-1. File type/source/destination

Item	Source	Destination
Panel setup (xxxx.set)	<ul style="list-style-type: none"><li>• Panel settings</li></ul>	<ul style="list-style-type: none"><li>• Internal memory: S1 ~ S15</li><li>• External memory: USB</li></ul>
Waveform data (xxxx.csv)	<ul style="list-style-type: none"><li>• Channel 1, 2</li><li>• Math operation result</li><li>• Reference waveform A, B</li></ul>	<ul style="list-style-type: none"><li>• Internal memory: W1 ~ W15</li><li>• Reference waveform A, B</li><li>• External memory: USB</li></ul>
Display image (xxxx.bmp)	<ul style="list-style-type: none"><li>• Display image</li></ul>	<ul style="list-style-type: none"><li>• External memory: USB</li></ul>
Save All	<ul style="list-style-type: none"><li>• Display image (xxxx.bmp)</li><li>• Waveform data (xxxx.csv)</li><li>• Panel settings (xxxx.set)</li></ul>	<ul style="list-style-type: none"><li>• External memory: USB</li></ul>

## 5-3-2. Saving the panel settings

---

### Procedure

1. (For saving to USB flash drive) Insert the USB flash drive into the front panel USB port.

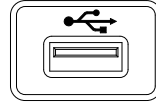

2. Press the Save/Recall key twice to access the Save menu.



3. Press *Save Setup*.



4. Press *Destination* repeatedly to select the saved location. Use the Variable knob to change the internal memory location (S1 ~ S15).



VARIABLE



Memory      Internal memory, S1 ~ S15

USB          USB, no practical limitation for the amount of files. When saved, the setup file will be placed in the root directory.

5. Press *Save* to confirm saving. When completed, a message appears at the bottom of the display.



Note 

The file will not be saved if the power is turned off or the USB flash drive is removed before completion.

---

### File utilities

To edit the USB drive contents (create/ delete/ rename files and folders), press *File Utilities*. For details, see page 81.



### 5-3-3. Saving the waveform

Procedure

1. (For saving to USB flash drive) Insert the USB flash drive into the front panel USB port.

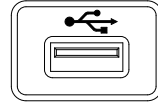

2. Press the Save/Recall key twice to access the Save menu.

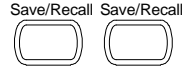

3. Press *Save Waveform*.



4. Press *Source*. Use the Variable knob to select the source signal.

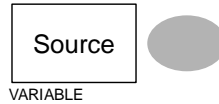

VARIABLE



- CH1 ~ CH2 Channel 1 ~ 2 signal
- Math Math operation result (page 41)
- RefA, B Internally stored reference waveforms A, B

5. Press *Destination* repeatedly to select the file destination. Use the Variable knob to select the memory location.

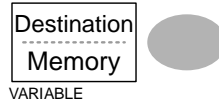

VARIABLE



- Memory Internal memory, W1 ~ W15
- USB Save to the USB flash drive with a 4k waveform memory length.
- Ref Internal reference waveform, A/B

6. Press *Save* to confirm saving. When completed, a message appears at the bottom of the display.













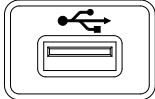

Note  The file will not be saved if the power is turned off or the USB flash drive is removed from the USB port.



File utilities

To edit the USB drive contents (create/ delete/ rename files and folders), press *File Utilities*. For details, see page 81.





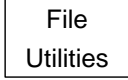

### 5-3-4. Saving the display image

Background	Saving the display image can be used as a screen capture or it can be used as a reference waveform.	
Procedure	<ol style="list-style-type: none"> <li>1. Insert the USB flash drive into the front panel USB port. (Image files can only be saved to USB)</li> <li>2. Press the Save/Recall key twice to access the Save menu.</li> <li>3. Press <i>Save Image</i>.</li> <li>4. Press <i>Ink Saver</i> repeatedly to invert the background color (on) or not (off).</li> <li>5. Note: <i>Destination</i> is set as USB. This cannot be changed.</li> <li>6. Press <i>Save</i> to confirm saving. When completed, a message appears at the bottom of the display.</li> </ol>	          
	<p>Note  The file will not be saved if the power is turned off or the USB flash drive is removed before completion.</p>	

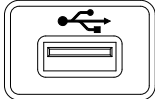
File utilities	To edit the USB drive contents (create/ delete/ rename files and folders), press <i>File Utilities</i> . For details, see page 81.	 
----------------	--	---

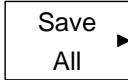
### 5-3-5. Saving all

Procedure	<ol style="list-style-type: none"> <li>1. (For saving to USB flash drive) Insert the USB flash drive into the front panel USB port.</li> <li>2. Press the Save/Recall key twice to access the Save menu.</li> <li>3. Press <i>Save All</i>. The following information will be saved.</li> </ol>	    
-----------	---	---

Setup file (Axxxx.set) Two types of setups are saved: the current panel setting and the last internally saved settings (one of S1 ~ S15).

Display image (Axxxx.bmp) The current display image in bitmap format.

Waveform data (Axxxx.csv) Two types of waveform data are saved: the currently active channel data and the last internally saved data (one of W1 ~ W15).

4. Press *Ink Saver* repeatedly to invert the background color (on) or not (off) for the display image.

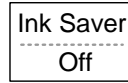

5. Press *Destination*.



USB Save to the USB flash drive with a 4k waveform memory length.

6. Press *Save* to confirm saving. When completed, a message appears at the bottom of the display.



Note  The file will not be saved if the power is turned off or the USB flash drive is removed from the USB port. .

7. The current waveform(s) (\*.CSV), setup file (\*.SET) and display image (\*.BMP) are saved to a directory (ALLXXXX).

---

File utilities

To edit the USB drive contents (create/ delete/ rename files and folders), press *File Utilities*. For details, see page 81.

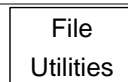



## 5-4. Recall

### 5-4-1. File type/source/destination

Item	Source	Destination
Default panel setup	<ul style="list-style-type: none"> <li>Factory installed setting</li> </ul>	<ul style="list-style-type: none"> <li>Current front panel</li> </ul>
Reference waveform	<ul style="list-style-type: none"> <li>Internal memory: A, B</li> </ul>	<ul style="list-style-type: none"> <li>Current front panel</li> </ul>
Panel setup (DSxxxx.set)	<ul style="list-style-type: none"> <li>Internal memory: S1 ~ S15</li> <li>External memory: USB flash drive</li> </ul>	<ul style="list-style-type: none"> <li>Current front panel</li> </ul>
Waveform data (DSxxxx.csv)	<ul style="list-style-type: none"> <li>Internal memory: W1 ~ W15</li> <li>External memory: USB flash drive</li> </ul>	<ul style="list-style-type: none"> <li>Reference waveform A, B</li> </ul>

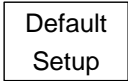
### 5-4-2. Recalling the default panel settings

Procedure	<ol style="list-style-type: none"> <li>Press the Save/Recall key.</li> <li>Press <i>Default Setup</i>. The factory installed setting will be recalled.</li> </ol>	 
-----------	---	--

Setting contents	The following is the default panel setting contents.	
Acquisition	Mode: Normal	
Channel	Coupling: DC	Invert: Off
	BW limit: Off	Probe attenuation: x1
Cursor	Source: CH1	Horizontal: None
	Vertical: None	
Display	Type: Vectors	Accumulate: Off
	Graticule: 	
Horizontal Math	Scale: 2.5us/div	Mode: Main Timebase
	Type: + (Add)	Channel: Off
Measure Trigger	Position: 0.00 div	Unit/div: 2V
	Item: Vpp, Vavg, Frequency, Duty cycle, Rise Time	
Utility	Type: Edge	Source: Channel1
	Mode: Auto	Slope: 
	Coupling: DC	Rejection: Off
	Noise Rejection: Off	
	SavImage, InkSaver On	
	Probe squarewave 1kHz 50% duty.	

### 5-4-3. Recalling a reference waveform to the display

---

Procedure

1. The reference waveform must be stored in advance. See page 86 for details.
2. Press the Save/Recall key.
3. Press *Display Refs.* The reference waveform display menu appears.
4. Select the reference waveform, *Ref A* or *Ref B*, and press it. The waveform appears on the display and the period and amplitude of the waveform appears in the menu.
5. To clear the waveform from the display, press *RefA/B* again.

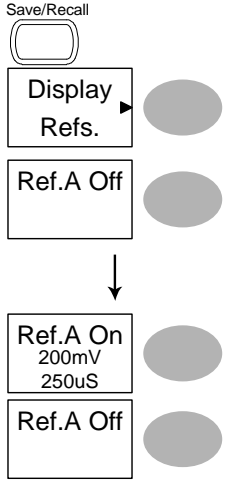

## 5-4-4. Recalling panel settings

---

### Procedure

1. (For recalling to USB) Insert the USB flash drive into the front panel USB port.

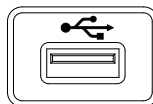

2. Press the Save/Recall key.



3. Press *Recall Setup*.

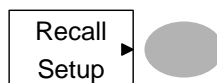

4. Press *Source* repeatedly to select the file source, internal or external memory. Use the Variable knob to change the memory.

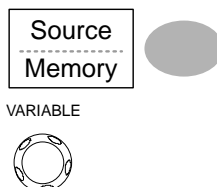

Memory Internal memory, S1 ~ S15

USB USB flash drive, DSXXXX.SET. The setup file(s) must be placed in the root directory to be recognized.

5. Press *Recall* to confirm recalling. When completed, a message appears at the bottom of the display.

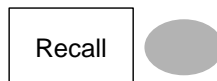

Note  The file will not be recalled if the power is turned off or the USB flash drive is removed before completion.

---

### File utilities

To edit the USB drive contents (create/ delete/ rename files and folders), press *File Utilities*. For details, see page 81.





## 6. MAINTENANCE

Two types of maintenance operations are available: calibrating the vertical resolution, and compensating the probe. Run these operations when using the oscilloscope in a new environment.

### 6-1. Vertical Resolution Calibration

Procedure

1. Press the Utility key.



2. Press the More key twice.



x2

3. Press Self Cal Menu.

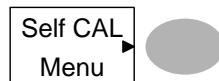

4. Press Vertical. The message "Set CAL to CH1, then press F5" appears at the bottom of the display.



5. Connect the calibration signal between the rear panel CAL out terminal and the Channel1 input.

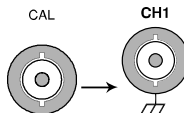

6. Press F5. The calibration automatically starts.

7. The Channel1 calibration will complete in less than 5 minutes.

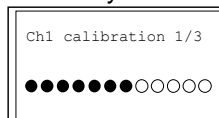

8. When finished, connect the calibration signal to the Channel 2 input and repeat the procedure.

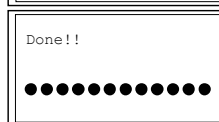

9. When the calibration is complete the display will go back to the previous state.

## 6-2. Probe Compensation

### Procedure

1. Connect the probe between the Channel1 input and the probe compensation output (2Vp-p, 1kHz square wave) on the front panel. Set the probe voltage attenuation to x10.

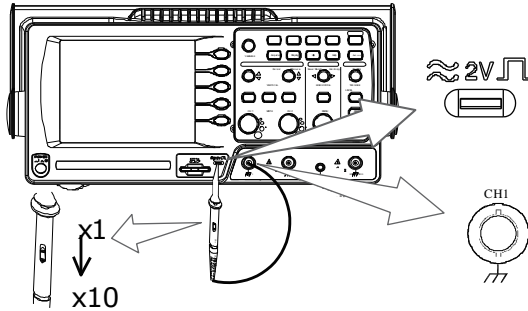

2. Press the Utility key.



3. Press *ProbeComp*.

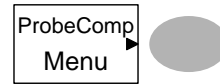

4. Press *Wavetype* repeatedly to select the standard square wave.

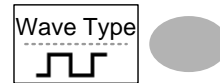

5. Press the Autoset key. The compensation signal will appear in the display.



6. Press the Display key, then *Type* to select the vector waveform.

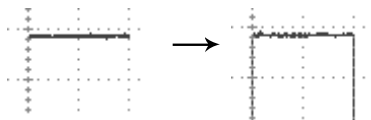
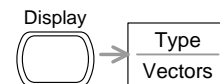

7. Turn the adjustment point on the probe until the signal edge becomes sharp.

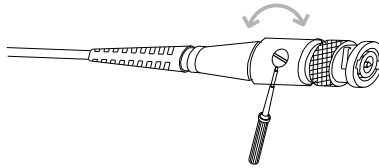
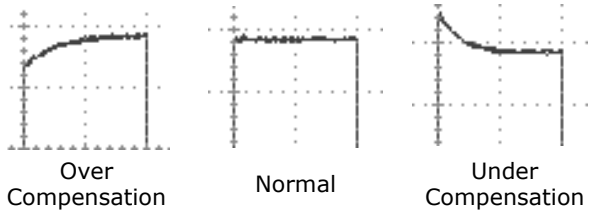

# 7. APPENDIX

## 7-1. Fuse Replacement

---

- Procedure
1. Remove the power cord and remove the fuse socket using a minus driver.

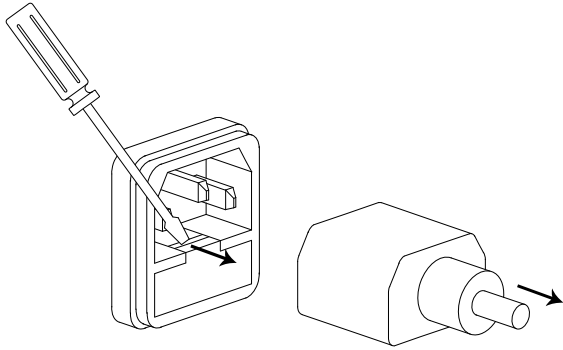

2. Replace the fuse in the holder.

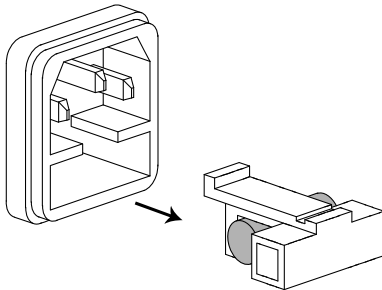

---

Ratings      T1A, 250V

## 7-2. DCS-4605 Specifications

The specifications apply when the oscilloscope is powered on for at least 30 minutes under +20°C~+30°C.

### 7-2-1. Specifications

Vertical	Sensitivity	2mV/div~10V/div (1-2-5 increments)	
	Accuracy	± (3% x  Readout +0.1div + 1mV)	
	Bandwidth (-3dB)	DC coupling: DC ~ 50MHz	
		AC coupling: 10Hz ~ 50MHz	
	Rise Time	< 7ns approx.	
	Input Coupling	AC, DC, Ground	
	Input Impedance	1MΩ±2%, ~15pF	
	Polarity	Normal, Invert	
	Maximum Input	300V (DC+AC peak), CAT II	
	Math Operation	+, -, FFT	
	Offset Range	2mV/div ~ 50mV/div	: ±0.4V
100mV/div ~ 500mV/div		: ±4V	
1V/div ~ 5V/div		: ±40V	
10V/div		: ±300V	
Bandwidth Limit	20MHz (-3dB)		
Trigger	Sources	CH1, CH2, Line, External	
	Modes	Auto / Normal / Single , Edge / TV / Pulse	
	Coupling	AC, DC, LF rej, HF rej, Noise rej	
	Trigger Sensitivity	0.5div or 5mV (DC ~ 25MHz)	
1.5div or 15mV (25MHz~50MHz)			
External trigger	Range	DC: ±15V, AC: ±2V	
	External Trigger Sensitivity	~ 50mV (DC~25MHz) ~ 100mV (25MHz~50MHz)	
	Input Impedance	1MΩ±2%, ~15pF	
	Maximum Input	300V (DC+AC peak), CATII	
	Horizontal	Range	1ns/div~50s/div, 1-2.5-5 increment Roll: 50ms/div – 50s/div
Modes		Main, Window, Window Zoom, Roll, X-Y	
Accuracy		±0.01%	
Pre-Trigger		10 div maximum	
Post-Trigger		1000 div	
X-Y Mode		X-Axis Input	Channel 1
	Y-Axis Input	Channel 2	
	Phase Shift	±3° at 100kHz	
Signal Acquisition	Real-Time	250MS/s maximum	
	Equivalent	25G S/s maximum	
	Vertical Resolution	8 bits	

	Record Length	4kPoint
	Acquisition	Normal, Peak Detect, Average
	Peak Detection	10ns (500ns/div ~ 50s/div)
	Average	2, 4, 8, 16, 32, 64, 128, 256
Cursors and Measurement	Voltage	Vpp, Vamp, Vavg, Vrms, Vhi, Vlo, Vmax, Vmin, Rise Preshoot/ Overshoot, Fall Preshoot/ Overshoot
	Time	Freq, Period, Rise Time, Fall Time, + Width, – Width, Duty Cycle
	Cursors	Voltage difference ( $\Delta V$ ) and Time difference ( $\Delta T$ ) between cursors
	Auto Counter	Resolution: 6 digits, Accuracy: $\pm 2\%$ Signal source: All available trigger source except the Video trigger
Control Panel Function	Autoset	Automatically adjust Vertical Volt/div, Horizontal Time/div, and Trigger level
	Save/Recall	Up to 15 sets of measurement conditions and waveforms
Display	LCD	5.7 inch, TFT, brightness adjustable
	Resolution (dots)	234 (Vertical) x 320 (Horizontal)
	Graticule	8 x 10 divisions
	Display Contrast	Adjustable
Interface	USB Slave Connector	USB1.1 & 2.0 full speed compatible (flash disk not supported)
	USB Host connector	Image (BMP) and waveform data (CSV)
Probe Compensation Signal	Frequency range	1kHz ~ 100kHz adjustable, 1kHz step
	Duty cycle	5% ~ 95% adjustable, 5% step
	Amplitude	2Vpp $\pm 3\%$
Power Source	Line Voltage	100V~240V AC, 47Hz~63Hz
	Power Consumption	18W, 40VA maximum
	Fuse Rating	T1A, 250V
Operation Environment	Ambient temperature	0 ~ 50°C
	Relative humidity	$\leq 80\%$ , 40°C or below $\leq 45\%$ , 41°C~50°C
Storage Environment	Storage Temperature:	-10°C~60°C, no condensation- Relative humidity 93% @ 40°C / 65% @ 41°C~60°C
Dimensions	341.5(W) x 162.3(H) x 159(D) mm	
Weight	Approx. 2.5kg	
Accessory	AC Power cord	x1
	Probe (See Probe Specifications)	x2
	ACCESSORY CD-ROM	x1
	USING THE PRODUCT SAFETY	x1

## 7-2-2. Probe Specifications

model	GTP-070A-4*	
Position x 10	Attenuation Ratio	10:1
	Bandwidth	DC ~ 70MHz
	Input Resistance	10MΩ when used with 1MΩ input
	Input Capacitance	28pF~32pF
	Maximum Input Voltage	≤600Vpk, Derating with frequency
Position x 1	Attenuation Ratio	1:1
	Bandwidth	DC ~ 6MHz
	Input Resistance	1MΩ when used with 1MΩ input
	Input Capacitance	120pF~220pF
	Maximum Input Voltage	≤200Vpk, Derating with frequency
Operating Cond.	Temperature	-10°C ~ 50°C
	Relative Humidity	≤85%
Safety Standard	EN 61010-031 CAT II	

\* Note: TEXIO TECHNOLOGY reserves the right to change the probe model type at anytime without notice for probe model types of similar specification.

### 7-3. Dimensions

#### FRONT

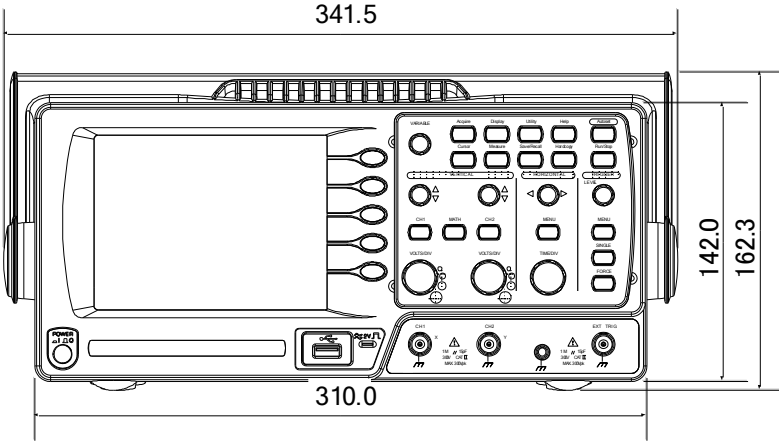

#### SIDE

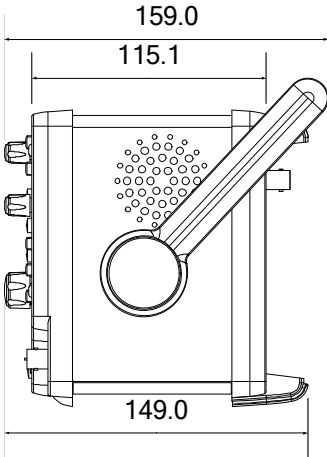

## 7-4. FAQ

---

- **The input signal does not appear in the display.**
- **I want to remove some contents from the display.**
- **The waveform does not update (frozen).**
- **The probe waveform is distorted.**
- **Autoset does not catch the signal well.**
- **I want to clean up the cluttered panel settings.**
- **The accuracy does not match the specifications.**

- **The input signal does not appear in the display.**

---

Make sure you have activated the channel by pressing the CH key (page 29).

- **I want to remove some contents from the display.**

---

To clear the math result, press the Math key again (page 41).

To clear the cursor, press the Cursor key again (page 39).

To clear the Help contents, press the Help key again (page 28).

- **The waveform does not update (frozen).**

---

Press the Run/Stop key to unfreeze the waveform. See page 31 for details. For trigger setting details, see page 65.

If this does not help, press the CH key. If the signal still does not appear, press the Autoset key.

- **The probe waveform is distorted.**

---

You might need to compensate the probe. For details, see page 94.

Note that the frequency accuracy and duty factor are not specified for probe compensation waveforms and therefore it should not be used for other reference purposes.

- **Autoset does not catch the signal well.**

---

The Autoset function does not catch signals well under 30mV or 30Hz. Please operate the oscilloscope manually.

- **I want to clean up the cluttered panel settings.**

---

Recall the default settings by pressing the Save/Recall key→Default Setting. For default setting contents, see page 27.

- **The saved display image is too dark on the background.**

---

Use the Inksaver function which reverses the background color. For details, see page 87.

- **The accuracy does not match the specifications.**

---

Make sure the device is powered on for at least 30 minutes, within +20°C~+30°C. This is necessary to stabilize the unit to match the specification.

For more information, contact your local dealer or TEXIO TECHNOLOGY at [www.texio.co.jp](http://www.texio.co.jp) / [info@texio.co.jp](mailto:info@texio.co.jp).



## TEXIO TECHNOLOGY CORPORATION

7F Towa Fudosan Shin Yokohama Bldg., 2-18-13, Shin Yokohama, Kohoku-ku,  
Yokohama, Kanagawa, 222-0033, Japan.

<http://www.texio.co.jp/>

---